

DESKTOP CADDY SETUP GUIDE

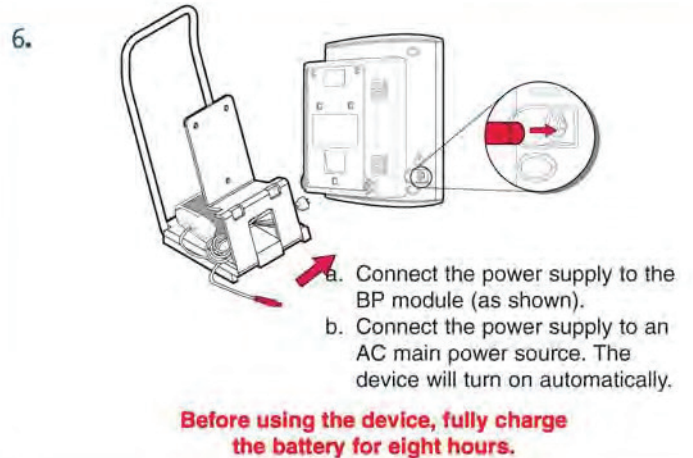
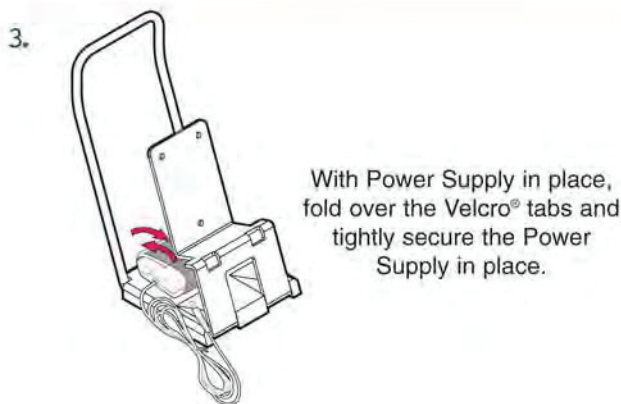
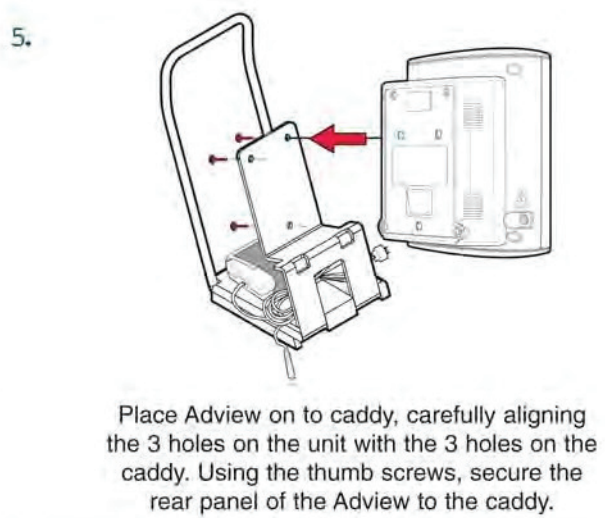
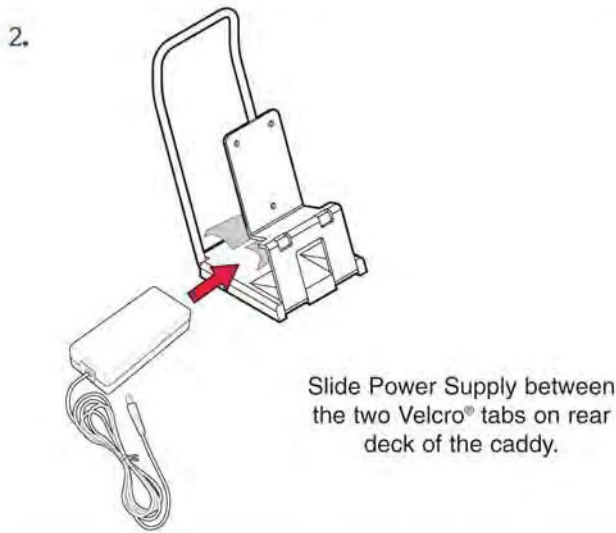
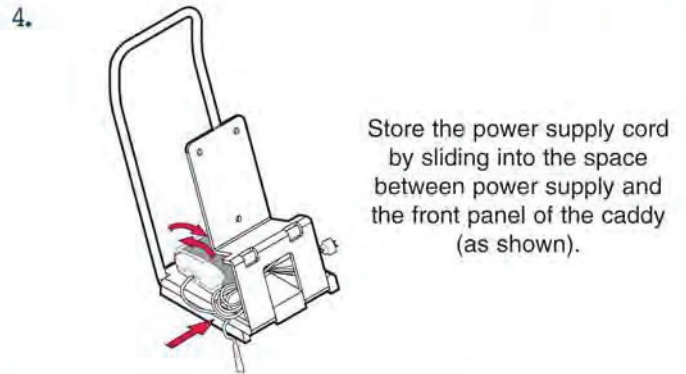

ADC
55 Commerce Drive
Hauppauge, NY 11788

EC REP
Suntech Medical, Ltd.
Oakfield Industrial Estate
Eynsham, Oxfordshire
OX29 4TS UK

Inspected in the U.S.A.
Made in China
tel: 631-273-9600
toll free: 1-800-232-2670
fax: 631-273-9659

www.adctoday.com/adview
info@adctoday.com

To Register Your Product, visit us at
www.adctoday.com
and follow the links

For questions, comments, or suggestions,
call in the U.S.A. Toll Free:
1-800-ADC-2670

 **IMPORTANT NOTE:**

The ADC Adview must be plugged in and charged before first use.

The ADC Adview battery is not shipped from the factory with a full charge. Before turning the device on for the first time, connect the device to the power supply, and connect the power supply to an AC mains power source. Leave it connected for 8 to 12 hours to fully charge the battery before use.

 **REMARQUE IMPORTANTE:**

Le ADC Adview doit être branché et chargé avant la première utilisation.

À l'usine, le ADC Adview Battery n'est pas complètement chargé avant son expédition. Avant la première mise en marche de l'appareil, reliez-le au bloc d'alimentation et connectez le bloc d'alimentation à la source d'alimentation c.a.. Laissez-le branché pendant une durée de 8 à 12 heures afin de recharger complètement la batterie avant utilisation.

 **WICHTIGER HINWEIS:**

Der ADC Adview muss vor dem ersten Einsatz ans Netz angeschlossen werden, damit der Akku geladen ist.

Der Akku des ADC Adview ist bei Auslieferung nicht voll geladen. Vor dem ersten Einschalten verbinden Sie das Gerät über das Netzteil mit dem Stromnetz. Lassen Sie es 8 bis 12 Stunden angeschlossen, damit der Akku vor dem Einsatz vollständig geladen wird.

 **NOTA IMPORTANTE:**

Il ADC Adview deve essere collegato e ricaricato prima del primo utilizzo.

La batteria del ADC Adview non viene inviata dalla fabbrica completamente carica. Prima di accendere il dispositivo per la prima volta, collegare il dispositivo all'alimentatore e quest'ultimo ad una fonte di alimentazione CA di rete. Lasciare il dispositivo collegato per 8-12 ore al fine di caricare completamente la batteria.

 **NOTA IMPORTANTE:**

El ADC Adview debe enchufarse y cargarse antes del primer uso.

La batería del ADC Adview no se suministra con la carga completa de fábrica. Antes de encender el dispositivo por primera vez, conéctelo a la fuente de alimentación y luego enchufe ésta a la red eléctrica. Deje el dispositivo conectado entre 8 y 12 horas para cargar completamente la batería antes del uso.

 **OBSERVAÇÃO IMPORTANTE:**

Antes do primeiro uso, conectar o ADC Adview à tomada de parede para carregar a bateria.

A bateria do ADC Adview não é fornecida com carga completa. Antes de ligar o aparelho pela primeira vez, conectar o aparelho à fonte elétrica e, em seguida, a fonte à tomada de parede. Manter o aparelho conectado por 8 a 12 horas permitindo completar o ciclo de carga.

 **重要注释:**

首次使用前，必须将 ADC Adview 接入电源充电。

ADC Adview 电池出厂时未完全充满电。首次打开设备前，请将设备连接到电源，然后将电源连接至一个交流电网电源上。将电源接通8至12个小时，直至电池完全充满。

 **注記:**

ADC Adview を初めてご利用になる際は、装置を電源に接続して充電する必要があります。

ADC Adview 電池は、工場出荷時にフル充電されません。本装置を初めて使用する際は、装置を電源アダプタに接続してから、電源アダプタを電源コンセントに差し込みます。電池がフルに充電するまで、8~12時間は電源コンセントに接続したままにしてください。



ADC
55 Commerce Drive
Hauppauge, NY 11788

 Suntech Medical, Ltd.
Oakfield Industrial Estate
Eynsham, Oxfordshire
OX29 4TS UK

Inspected in the U.S.A.
Made in China
tel: 631-273-9600
toll free: 1-800-232-2670
fax: 631-273-9659

www.adctoday.com/adview
info@adctoday.com



ADC[®] powered by SunTech[®]

ADview[™] Modular Diagnostic Station

**Blood Pressure Device for Automated and Manual
Measurement**

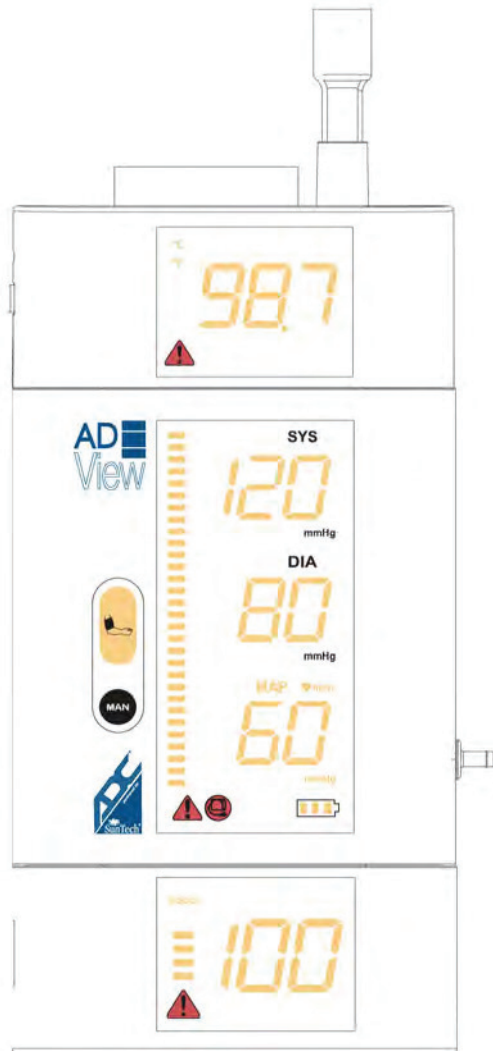

About this Manual

This manual describes features and uses of the ADC[®] by SunTech[®] *ADview*[™] a non-invasive, clinical-grade automated device to measure blood pressure, pulse rate and mean arterial pressure. Optional modules to measure temperature and functional oxygen saturation are available, and their use is also described in this manual.

- This manual accompanies all the versions of the *ADview* :

<i>ADview</i> Versions*	
Item Name	Item Description
<i>ADview</i> Battery: BP	BP device with rechargeable battery
<i>ADview</i> Battery: BP & Temperature	BP device with temperature and rechargeable battery
<i>ADview</i> Battery: BP & SpO ₂	BP device with SpO ₂ and rechargeable battery
<i>ADview</i> Battery: BP, Temperature & SpO ₂	BP device with SpO ₂ , temperature, and rechargeable battery

* All above versions are available with a Bluetooth wireless communication option.

This document is designed to help you quickly familiarize yourself with your *ADview*, and subsequently, to use it to its full potential. Dispersed throughout the body of the manual are tips, notes and warnings to enable you to use your *ADview* easily, safely and effectively.

Changes and Reissues

This manual is identified as Part Number: 93-9000UM-00. Changes occurring between issues of this document are addressed through change information sheets, addenda, or replacement pages. If none of these accompany this manual, the manual is correct as printed.

Should you notice errors or omissions in this manual, please notify us at:

ADC by SunTech

55 Commerce Drive

Hauppauge, New York 11788

USA

Phone: 631.273.9600

Fax: 631.273.9659

E-mail: info@adctoday.com

Copyright Information

All content in this manual is the proprietary information of *ADC by SunTech* and is provided solely for purposes of operation, maintenance or service of the *ADview*. This manual and the *ADview* described in it are protected under copyright law under which they may not be copied, in whole or in part, without written consent of *ADC*.

ADview is a registered trademark of *ADC*. All other trademark names are the trademarks of their respective holders.

The information in this manual is furnished for guidance only, is subject to change without notice, and should not be construed as a commitment by *ADC*. *ADC* assumes no liability for errors or inaccuracies that may appear in this manual.

© 2012 *ADC*. All rights reserved.

KEYS AND ACRONYMS

Acronyms

Acronyms commonly used in this document include:

APC	An <i>ADC</i> proprietary acronym for “All Purpose Cuff”
BP	Blood pressure
HR	Pulse rate
K-sound	Korotkoff sound
MAP	Mean arterial pressure
NIBP	Non-invasive blood pressure
EMR/EHR	Electronic Medical Records/Electronic Health Records

Document Key

This manual uses the following icons to call attention to specific instructions or guidance.



TIP: A step or process that eases or enhances your use of your *ADview* device.



NOTE: Indicates something you *must* do to use your device correctly and effectively.



CAUTION: Warns you that not following these instructions can cause injury, harm or serious damage.

Indications for Use

The *ADview* NIBP, Temperature, and Pulse Oximeter device is indicated for use in measuring and displaying Systolic and Diastolic blood pressures, pulse rate, temperature, and functional oxygen saturation (SpO₂) of adult and pediatric patients in hospitals, medical facilities, clinics, physicians offices, and other sub-acute environments.

User Responsibility



Your *ADview* product is designed to perform in conformity with the description contained in this operation manual and accompanying labels and inserts, when assembled, operated, maintained and repaired in accordance with the instructions provided. It is your responsibility to:







- Check calibration of the device annually.
- Never knowingly use a defective device.
- Immediately replace parts that are broken, worn, missing, incomplete, damaged or contaminated.
- Contact the nearest factory approved service center should repair or replacement become necessary. A list of approved service centers appears on pages 48-46 or on our website at www.adctoday.com/adview.

Further, the user of the device bears sole responsibility for any malfunction that results from improper use, faulty maintenance, improper repair, damage or alteration by anyone other than *ADC* or authorized service personnel.

Warnings and Contraindications

Please read this manual thoroughly before starting to use your *ADview*. Only those clinicians trained to measure, record and interpret vital signs should use this device.

	Do not use this device on pediatric patients under 3 years old, infants, or neonates.
	The <i>ADview</i> must be charged before using it for the first time.

	<p>For accurate blood pressure measurements, ensure that the circumference of the arm fits within the range markings on the cuff.</p>
	<p>The <i>ADview</i> is not intended for continuous monitoring. Although the blood pressure cuff and cable are defibrillator proof, the temperature probe and SpO₂ sensor are not. Do not leave the device unattended while taking measurements on a patient.</p>
	<p>Only use such accessories as are recommended for use with this device. A list of recommended accessories is on pages 59-63.</p>
	<p>Do not operate the <i>ADview</i> near flammable anesthetics or volatile vapors. An explosion may result.</p>
	<p>Compressing the pneumatic tubing may cause system errors.</p>
	<p>Do not use the device if it has failed its diagnostic self test or if it displays a greater than zero pressure with no cuff attached or a value of functional oxygen saturation or temperature with no sensor attached.</p>
	<p>Prevent water or other fluids from entering any connectors or vents on the device. Should this happen, all connectors should be dried with warm air. Then check the calibration of the device and operating functions before reusing.</p>







	<p>Do not make repairs yourself. Equipment must be returned to <i>ADC</i> or authorized service personnel for repairs. Substitution of a component different from that supplied may result in measurement error.</p>
	<p>If the <i>ADview</i> is dropped or mishandled, please have it checked by an authorized service center before bringing it back into use.</p>
	<p>The <i>ADview</i> is not intended for patients connected to a cardiopulmonary bypass machine.</p>
	<p>At least every three months, inspect probes, cords and accessories for fraying or other mechanical damage. Replace as necessary.</p>
	<p>Check the calibration of your <i>ADview</i> at least once a year.</p>
	<p>If Luer Lock connectors are used in the constructions of tubing, there is a possibility that they might be inadvertently connected to intravascular fluid systems, allowing air to be pumped into a blood vessel.</p>

TABLE OF CONTENTS

Changes and Reissues	iii
Copyright Information	iv
KEYS AND ACRONYMS.....	V
Acronyms.....	v
Document Key	v
Indications for Use	vi
User Responsibility.....	vi
Warnings and Contraindications	vi
TABLE OF CONTENTS	IX
GETTING TO KNOW THE <i>ADVIEW</i>.....	1
Package Contents.....	1
The <i>ADview</i> Kit.....	1
Accessory Modules.....	2
Other Accessories.....	2
A Bird’s Eye View.....	3
BP module	3
BP display.....	5
Optional temperature and pulse oximetry modules.....	6
Optional temperature and pulse oximetry displays.....	8
Icons and Cues.....	9
Auditory Cues	9
Visual Cues – Battery Icon.....	10
Visual Cues – Blood Pressure Module.....	10
Visual Cues – Temperature Module.....	11
Visual Cues – Pulse Oximetry Module	12
QUICK START GUIDE	14
Measuring Blood Pressure and Pulse Rate Automatically	14
Measuring Blood Pressure Using Sphygmode.....	14
Measuring Temperature.....	15
Measuring Oxygen Saturation	15
SETTING UP THE <i>ADVIEW</i>.....	16
Safety Precautions.....	16
Protecting Your Patient.....	16
Protecting Yourself.....	16
Protecting Your <i>ADview</i>	16

Mounting Your Device	17
Mounting the Device on a Wall	17
Affixing the Device to a Mobile Stand	17
Placing the Device on a Tabletop	17
First-Time Setup	18
Charging the Battery	18
Connecting Your Device	18
Powering Up	19
Selecting Temperature Unit of Measurement	19
Bluetooth Wireless Communication	19
MEASURING BLOOD PRESSURE WITH THE <i>ADVIEW</i>	20
Prepping Your Patient	20
Selecting the Right Cuff	21
Taking a Measurement	22
Taking an Automated Measurement	22
Taking a Sphygmode Measurement	23
K-Sounds: A Primer	24
MEASURING TEMPERATURE WITH THE <i>ADVIEW</i>	25
Temperature Units of Measurement	25
Temperature Measurement Modes	25
Using temperature probe and probe covers	25
Taking an Oral Temperature	26
Taking an Axillary Temperature	26
Taking a Rectal Temperature	27
MEASURING OXYGEN SATURATION WITH THE <i>ADVIEW</i>	28
Prepping the Patient	28
Selecting the Right Sensor	28
Protecting Your Pulse Oximetry Sensors	28
Guidelines for Use	29
Measuring Oxygen Saturation with Sensor on Finger	29
MANAGING READINGS	31
Recalling the Last Set of Readings	31
Clearing the Last Set of Readings	31
Bluetooth Wireless Transmission of Readings	31
MAINTAINING THE <i>ADVIEW</i>	33
Routine Maintenance	33
Cleaning	33

Checking the Calibration of Your Device	34
Replacing the Rechargeable Battery	36
Attaching the Temperature Module.....	36
Attaching the Pulse Oximetry Module	38
Storage, Shutdown, Transport	40
Storage	40
Moving Your Device.....	40
TROUBLESHOOTING	42
Troubleshooting – Blood Pressure Module	42
Troubleshooting – Temperature Module	43
Troubleshooting – Pulse Oximetry Module	44
FAQs.....	46
Web Resources	48
Service Centers	48
For customers in the Americas.....	48
For customers in Europe, the Middle East, and Africa	49
For customers in Asia and the Pacific.....	49
SPECIAL SITUATIONS	50
Special Situations.....	50
Measuring Blood Pressure in Children	50
Measuring Blood Pressure in Obese Patients	50
Measuring Blood Pressure in the Presence of Arrhythmia.....	50
Measuring Blood Pressure During Pregnancy.....	50
Measuring Blood Pressure in the Elderly.....	50
Measuring Blood Pressure in the Emergency Room.....	50
Measuring Blood Pressure in the Presence of Orthostatic Hypotension.....	50
APPENDICES.....	52
Specifications	52
Compliance	53
Safety Requirements.....	53
EMC Statement	54
Symbols.....	54
EU and FCC Regulatory Information	59
Limited Warranty	60
Purchasing Parts and Accessories	61

GETTING TO KNOW THE *ADVIEW*

Your *ADview* is a model of functionality, offering consistent blood pressure measurements along with reliable temperature and functional oxygen saturation readings.

Package Contents



Upon opening your kit, please ensure that all listed contents are included. If any contents are missing or damaged, please contact *ADC*.

The *ADview* Kit

The *ADview* kit contains your rechargeable battery powered device. Your kit will also contain:

- An 8-foot blood pressure hose
 - Adult and large adult size all purpose cuffs
 - A wall mounting kit or tabletop stand kit (Mobile stand shipped in separate carton)
 - A 9v AC power supply
 - A geography specific power cord
 - A CD with this manual
 - A quick start guide
-



To register your product, visit us at www.adctoday.com/adview and follow the links.



The *ADview* must be plugged in and charged before first use.

Accessory Modules

Accessory modules that you can purchase from your distributor or *ADC* to enhance usability of your *ADview* include:

- A temperature module that includes the oral/axillary probe and one box of disposable probe covers. A rectal probe option is available separately.
- A Nellcor®-compatible pulse oximetry module with an adult reusable finger sensor (10ft/3.048m length).

Other Accessories

Many other accessories and sources for purchasing them are listed in the Appendix on pages 63-66. A few to note include:

- An APC Adult package (contains one each of the following cuff sizes: Small Adult, Adult, and Large Adult)
- An APC Pediatric cuff package (contains one each of the following cuff sizes: Child, Small Adult, and Adult)
- A rectal temperature kit compatible with the temperature module
- Other reusable pulse oximetry sensors

A Bird's Eye View

BP module

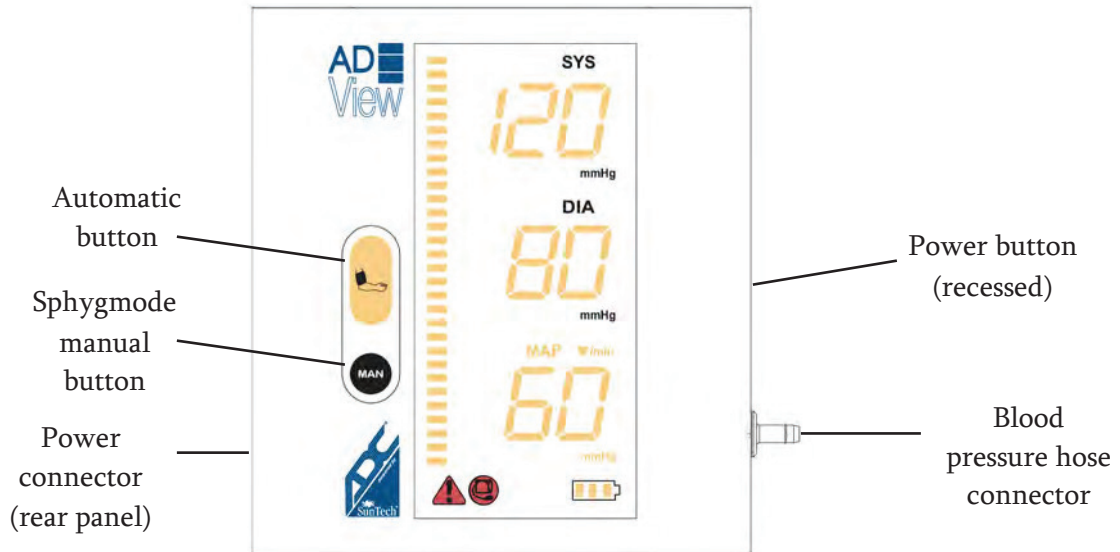



Connectors on the main BP module

- Power Connector: Connects to the power supply.
- Blood Pressure Hose Connector: Connects to the 8-foot pressure hose.

Buttons

The buttons are used for all actions on the interface, and provide tactile feedback when pressed.

Buttons on the main BP module

Button Functionality for the BP Module			
Button	Device Status	Action	Result
 Automatic	Idle	Select for less than 2 seconds	Start an automatic BP measurement.
		Select for 2 to 5 seconds	Redisplay last measurement values for all modules.
		Select for more than 5 seconds	Clear last measurement values for all modules.
	Taking an automatic <u>or</u> Sphygmode BP	Select	Aborts the BP measurement in progress.
	In Calibration Check mode	Select	Device exits Calibration Check mode and is ready to take measurements.
 Sphygmode Manual	Idle	Select	Inflates the cuff as long as the button is selected.
	Taking a Sphygmode BP	Select	Re-inflates the cuff as long as the button is selected.
	Taking an automatic BP	Select	Aborts the BP measurement in progress.
	In Calibration Check mode	Select	Device exits Calibration Check mode and is ready to take measurements.
 Power	Power off	Select	Turns on the device.
	Power on	Select	Turns off the device.
Automatic + Power	Power off	Hold the Automatic button down while selecting the Power button.	Device enters the Calibration Check mode.

Sphygmode Manual + Power	Power off	Hold the Sphygmode button down while selecting the Power button.	Device enables/disables MAP mode.
--------------------------------	-----------	--	-----------------------------------

BP display

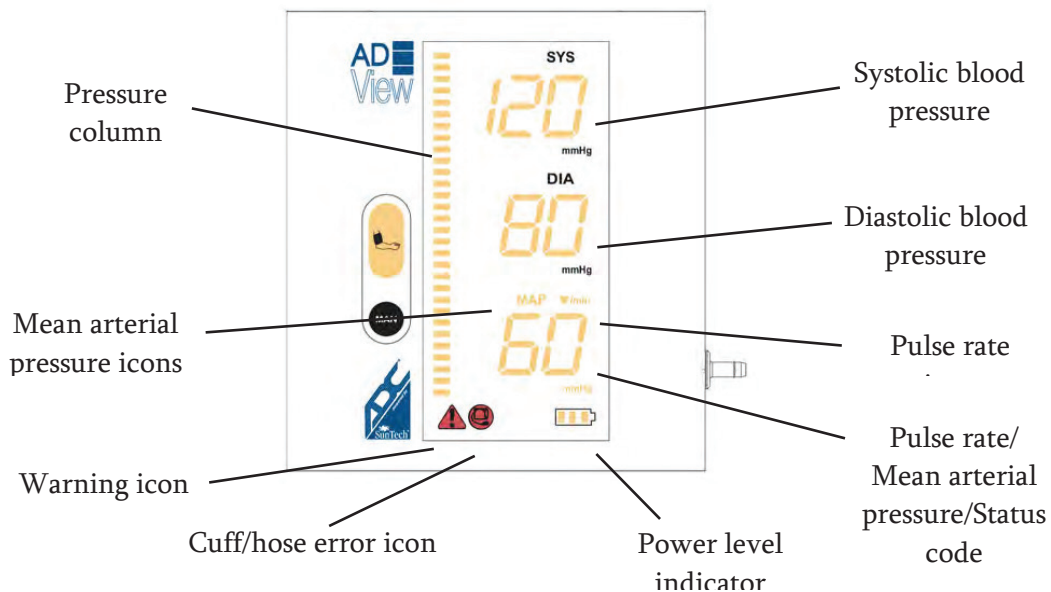

Information on the BP module display

- **Systolic blood pressure:** At the end of a measurement or when the last measurement is recalled, the patient's systolic BP is displayed. During a measurement, the cuff pressure is displayed.
- **Diastolic blood pressure:** At the end of a measurement or when the last measurement is recalled, the patient's diastolic BP is displayed.
- **Pulse rate/Mean arterial pressure (MAP):** At the end of a measurement or when the last measurement is recalled, the patient's pulse rate is displayed. When the MAP feature is enabled, MAP toggles with pulse rate. If the cuff/hose error and warning icons are lit, a status code may appear in this space. See page 43 for details.

- Pulse rate icon: When displayed, the value below is the patient's pulse rate.
- Mean arterial pressure icon: When displayed, the value below is the patient's MAP.
- Power level indicator: Displays connection to AC power or the charge level of the battery.
- Cuff/hose icon: When displayed, indicates that the cuff and/or pneumatic hose need to be checked and adjusted in order to take a measurement. See page 42 for details.
- Warning icon: When displayed, indicates that the system needs to be checked. See page 42 for details.
- Pressure column: Displays the pressure in the cuff. Each segment represents approximately 10mmHg.

Optional temperature and pulse oximetry modules

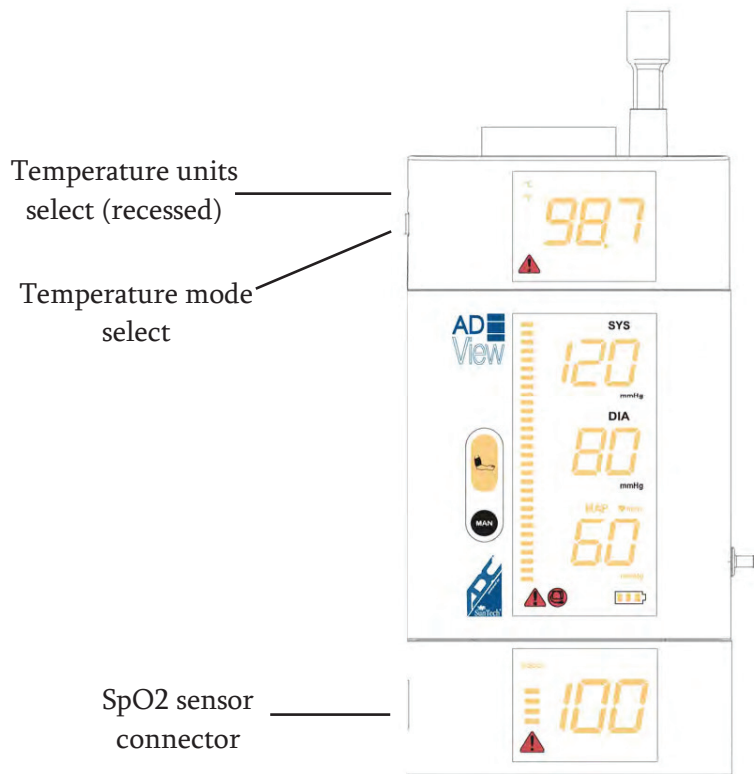

Buttons on the optional temperature module

- Temperature units select: Recessed momentary switch that toggles the display between °F and °C.
- Temperature mode select (symbol on button: ): Momentary switch that selects oral vs. axillary measurements for the oral temperature probe, and selects predictive vs. direct measurement methods for all probes.

Connectors on the optional temperature module

- Temperature unit connector: Located on the temperature module, connects to the temperature probe housed in the temperature probe well.

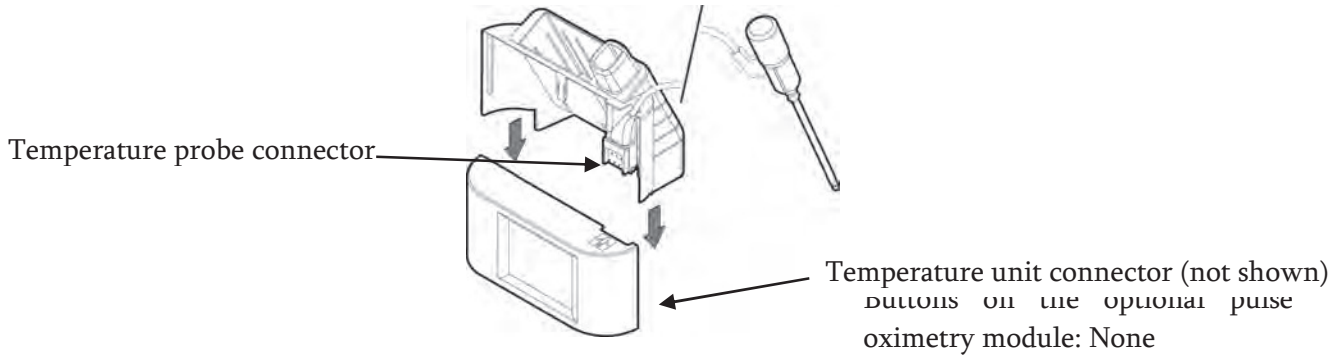

Connectors on the optional pulse oximetry module

- SpO₂ sensor connector: Connects to a SpO₂ sensor.
See page 66 for compatible accessories.

Optional temperature and pulse oximetry displays

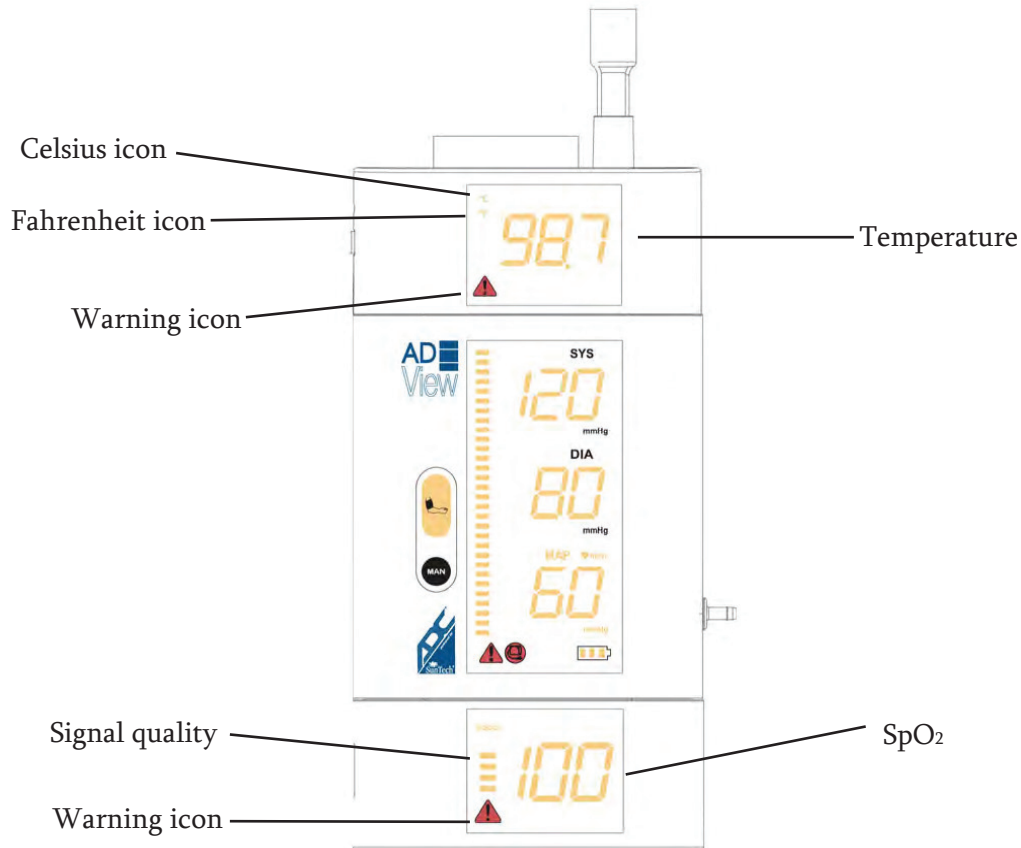

Information on the optional temperature module display

- Temperature: At the end of a measurement, the patient's temperature is displayed. During a measurement, displays the probe type and related information. If the warning icon is lit, displays the status code. See page 43 for details.
- Celsius icon: When lit, the value below is displayed in degrees Celsius.
- Fahrenheit icon: When lit, the value is displayed in degrees Fahrenheit.
- Warning icon: When displayed, indicates that the system needs to be checked. See page 43 for details.

Information on the optional pulse oximetry module display

- SpO₂: At the end of a measurement, the functional oxygen saturation of the patient is displayed. If the warning icon is lit, displays the status code. See page 44 for details.
- Signal quality: During a measurement, indicates the quality of signal from the pulse oximeter sensor.

- Warning icon: When displayed, indicates that the system needs to be checked. See page 44 for details.

Icons and Cues

Your *ADview* is designed to provide unambiguous visual and auditory cues before, during and after a measurement. For easy reference, all cues are tabulated in this chapter.

- Audible cues, or beeps, identify stages in the measurement cycle.
- Icons illuminated within a module's display indicate measurement modes, processes or warnings.





Auditory Cues

The temperature and BP modules of the *ADview* are programmed with auditory cues. A listing of these cues appears below.

NUMBER OF BEEPS...	INDICATES...
One short beep after power up or right before powering down	The device is powered up and ready to use or the device is about to turn off.
One short beep after taking a measurement	Success – measurement taken.
Three short beeps	BP measurement error. Please check or take another measurement.
Three long beeps	A system error has occurred. Please refer to page 43 for troubleshooting.
One short beep followed by a long beep	You have aborted this BP measurement.

Visual Cues – Battery Icon





The battery icon indicates the status of the power supply as follows.

ICON/DISPLAY	INDICATES...
	Battery fully charged
	Battery is charging (segments animated)
	Power-off state
	As the charge level drops, the segments will be turned off in sequence from the right to the left.
	The battery charge is very low. Recharge before using. (segment flashing)



Visual Cues – Blood Pressure Module





Icons and numeric displays on your device assist you in taking quick and accurate readings.

ICON/DISPLAY	INDICATES...
SYS	The systolic BP, read in mmHg, displays immediately below this symbol.
DIA	The diastolic BP, read in mmHg, displays immediately below this symbol.
mmHg	Unit of measurement for SYS, DIA, and MAP
 /min	Pulse rate, in beats per minute, displays

ICON/DISPLAY	INDICATES...
	immediately below this symbol.
	If this icon is lit on power-up, MAP mode is enabled. After a measurement, this icon is lit when MAP is displayed in the space below.
	These letters are displayed in the pulse rate display area when you are checking the device's calibration.
	Indicates an issue associated with the cuff, its position, or connection. Please check the cuff and hose and try again. Additionally, check page 42 for troubleshooting details.
	Warning! The device is unable to take a valid reading. See page 42 for troubleshooting details.
	A measurement is in progress. If the column is rising, the cuff is being inflated; if the column is falling, the cuff is deflating. Each segment lit is approximately equivalent to 10 mmHg.



Visual Cues – Temperature Module

ICON/DISPLAY	INDICATES...
	Temperature shown in degrees Fahrenheit.
	Temperature shown in degrees Celsius.
 “Traveling dash” in temperature display	The unit is taking a measurement in predictive measurement mode.

ICON/DISPLAY	INDICATES...
	Warning! There is an error in the measurement or module. Please check the status code in the troubleshooting section on page 43 for details and solutions.
	The device is set to measure an oral temperature.
	The device is set to measure an axillary temperature.
	The device is set to measure a rectal temperature.
	The unit is taking a measurement in direct measurement mode. The display of <i>dir</i> alternates with the current probe temperature.
Temperature value flashes	The unit is taking a measurement in direct measurement mode, but the reading is currently out-of-range.
Temperature value flashes in an upward direction	Final measurement is greater than 109.4°F/43.0°C.
Temperature value flashes in a downward direction	Final measurement is less than 86°F /30.0°C.
Temperature value is steady (no flashing)	This is the final temperature value.

Visual Cues – Pulse Oximetry Module

ICON/DISPLAY	INDICATES...
--------------	--------------

ICON/DISPLAY	INDICATES...
 “Traveling dash” in SpO ₂ display	The unit is taking a measurement.
	Warning! Indicates an error in the optional pulse oximetry module. Please refer to the troubleshooting section on page 44.
	Indicates signal strength and quality from the pulse oximeter sensor. If there is no measurement and the signal quality is low, try a different site or sensor.
SpO ₂ value	Indicates the functional oxygen saturation. This area also displays the status code when the warning symbol is lit.

QUICK START GUIDE

If the device is off, turn it on by depressing the power button on the right side.

Measuring Blood Pressure and Pulse Rate Automatically

1. Wrap an appropriately sized cuff (sizes are tabulated on page 21) snugly around the upper arm midway between the elbow and shoulder.
2. Ask the patient to stay still and quiet before taking the measurement.





3. Press the automatic button on your unit. The cuff begins to inflate and the cuff pressure is shown in the systolic display.
4. In about 30–40 seconds, depending on the size of the cuff, you will hear a beep to indicate cycle completion. The systolic and diastolic values are shown in their respective locations. If MAP mode is enabled, the pulse rate and MAP values will alternate.

Measuring Blood Pressure Using Sphygmode

1. Wrap an appropriately sized cuff (sizes are tabulated on page 21) snugly around the upper arm midway between the elbow and shoulder.
2. Ask the patient to stay still and quiet.
3. Press and hold the Sphygmode manual button  to inflate the cuff. Watch the pressure displayed and release the button to start deflating the cuff at 3 mmHg/sec. Place your stethoscope on the brachial artery to take a Sphygmode measurement.



If you see the  cuff and/or warning icon , you will need to take another measurement. Please refer to the troubleshooting section on page 42.

Measuring Temperature

1. To measure temperature orally, remove the blue probe from its holder and secure a disposable cover on it. The display shows the type of measurement, *orL*.
2. Wait for the device to beep before placing the probe carefully under the patient's tongue as denoted by the heat pockets shown to the right. The posterior medial sublingual pocket is preferred for accuracy. Hold the probe in place so that its tip maintains tissue contact. Close the patient's mouth. During measurement, a "traveling dash"  is displayed. In approximately 10-15 seconds, you will hear a long beep and the temperature reading will display.
3. Remove the probe from the patient's mouth, discard the probe cover by pressing the button on the end of the probe handle and replace the probe in its holder, ready for the next measurement.

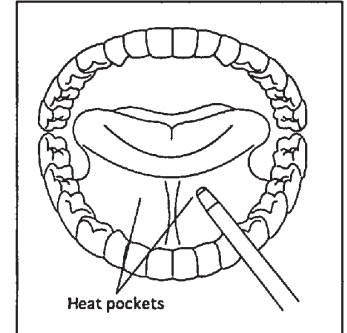

Measuring Oxygen Saturation

1. For the reusable finger sensor, insert the patient's digit, index most preferable, into the sensor. You will see a "traveling dash" until a valid reading is available, typically in 10-20 seconds. This reading is displayed along with the signal strength.

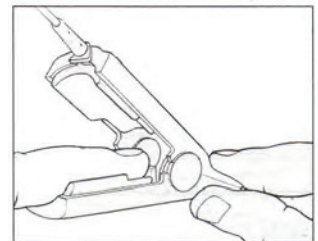

When selecting a sensor site, give priority to an extremity free of an arterial catheter, blood pressure cuff or intravascular infusion.

2. Detach the sensor carefully and replace it in the basket. At the end of the measurement, the last valid reading will flash for 8 seconds and then be displayed for two minutes or until the next measurement.

SETTING UP THE *ADVIEW*

Safety Precautions

As a clinically trained professional using the *ADview*, your responsibilities include safeguarding your patients, yourself and your equipment. Many setup functions will be performed either only once or very occasionally, and it is important that you pay close attention. Before you set up your *ADview*, please review these safety guidelines.

Protecting Your Patient

- While your *ADview* is designed for accurate, reliable vital signs measurement for adults and children, it is not to be used on patients connected to cardiopulmonary bypass machines, patients needing continuous monitoring, or patients under three years of age.
- If you feel that a particular blood pressure reading is questionable, use the *ADview* and your stethoscope to take a second, Sphygmode reading. If you would like confirmation for an SpO₂ or temperature reading, please use an alternate device. After taking confirmatory readings, check the device for proper functioning.
- Arrange the power supply and cabling so that it does not constitute a hazard to your patient, your co-workers or yourself.

Protecting Yourself

- Removing the cover or the back of the device can cause electric shocks. Do not attempt to service your *ADview* unless you are authorized.

Protecting Your *ADview*

- Do not use your *ADview* around flammable substances.
- Use only *ADC* approved accessories to power your *ADview*. A listing of these is in the Appendix starting on page 63.
- Use only those batteries supplied by *ADC* or an authorized service representative.
- The *ADview* must be placed on a stable, slip proof surface. Only recommended hardware should be used to mount your device to a wall, pole or tabletop carrier.
- At no point should the contents of the storage basket exceed 5 lbs. in weight.
- Do not immerse the device in water or attempt to gas sterilize or autoclave it.
- The reliability of your *ADview* depends upon conformance with the operation and service instructions as detailed in this manual.

Mounting Your Device

For convenience, you may mount your unit on the wall or attach it to a mobile stand or a tabletop stand. A storage basket is included and can be used to hold cuffs, boxes of probe covers for the optional temperature module, and SpO₂ sensors for the optional pulse oximetry module. All compatible accessories for mounting your *ADview* can be found in the list starting on page 63. All versions of the *ADview* can be mounted in the following ways:

Mounting the Device on a Wall

Mount the *ADview* on the wall in place of an aneroid manometer. To affix your *ADview* to the wall:

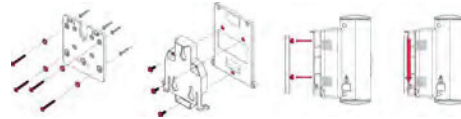

1. Attach the bracket to the wall using 4 wall screws, and the basket using 2 screws.
2. Attach the wall bracket adapter to the rear panel of the BP device using the 3 screws.
3. Position the adapter onto the rivets of the wall bracket and slide the device down until it locks into place.



The weight of the contents of the wall-mounted storage basket should never exceed five pounds. Please do not store heavy items in the storage basket.

Affixing the Device to a Mobile Stand

Attaching the *ADview* to a mobile stand facilitates portability. To mount the *ADview* to the mobile stand:

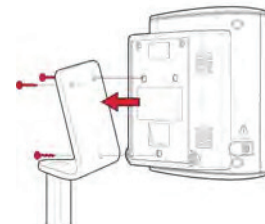

1. Assemble the mobile stand according to the manufacturer's directions.
2. Using the three thumb screws, secure the rear panel of the BP device to the stand.

Placing the Device on a Tabletop

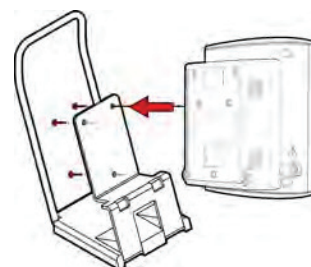

Use the *ADview* with the tabletop stand to make it easier to carry with you. To mount the *ADview* to the tabletop stand:

1. Using the three thumb screws, secure the rear panel of the BP device to the stand.



First-Time Setup



The *ADview* must be plugged in and charged before first use.

Charging the Battery

The *ADview* Battery is powered by a rechargeable 6V lead-acid battery or by AC power. To turn the device on for the first time, connect the device to the power supply, then the power supply to an AC mains power source. Leave it connected for 8 to 12 hours to fully charge the battery.

The charging status is indicated by the rotating sequence of lit segments  in the battery icon. When the battery is fully charged, all segments will be lit . A fully charged battery provides enough power for the device to make at least 200 measurements within a 12-hour period. The battery is guaranteed to last for 200 readings in an 8 hour period per charge.

Connecting Your Device

To maintain the easy readability and streamlined facade of your *ADview*, all connections are made through the back or sides of the enclosure.

Connectors on the BP enclosure are for:

- Blood pressure hose
- Power supply

Connectors on the optional modules are for:

- A pulse oximetry sensor on the pulse oximetry module
- A temperature probe on the temperature module

To connect the *ADview*:

1. For blood pressure measurements, the blood pressure hose should already be attached to the BP device. If not, push the open end of the blood pressure hose (one without the plastic connector) over the blood pressure hose connector on the module. Secure the end with the plastic connector to an appropriately sized cuff by twisting the two mating connectors together.
2. For temperature measurements, remove the tape holding the temperature probe in the well, and place the box of probe covers in the well next to the probe.
3. For SpO₂ measurements, attach the pulse oximetry cable into SpO₂ connector port in the module and flip the retention clip forward to locking position.
4. Connect the power supply to the main BP module. Then, connect the power supply to an AC mains power source. The device will turn on automatically.

Powering Up

1. Depress the power button located on the right side of the main enclosure. The power-up sequence begins. All display segments light up for three seconds. A short beep indicates that the *ADview* is ready.
2. Check the status of the power level indicator. If the power level indicator shows one segment flashing, connect the device to the power supply before using. You are now ready to use your *ADview*.

Selecting Temperature Unit of Measurement

With the device powered on, select the unit of measurement for temperature by depressing the recessed button on the side of the temperature module to toggle between the °C and °F icons. The selected icon will be lit in the display and becomes your default selection.

Bluetooth Wireless Communication

If your *ADview* has the optional Bluetooth wireless communication capability, please contact your IT administrator for configuration with your EMR/EHR system or communication network.

MEASURING BLOOD PRESSURE WITH THE *ADVIEW*

Your *ADview* device is designed to take accurate blood pressure readings by the oscillometric method. Systolic pressures from 60 to 270 mmHg and diastolic pressures from 30 to 170 mmHg lie within the range of your device. In most cases, you will be able to take accurate blood pressure (BP) and pulse rate (HR) measurements within 30-40 seconds.

Steps in taking a BP measurement are:

- Prepping the patient and attaching the cuff
- Taking the measurement

Prepping Your Patient

Ensure that the patient:

- Is not wearing any constricting clothing on the selected arm.
- Has no injury or tissue damage on the selected arm.
- Keeps the cuffed arm at heart level.
- Keeps the cuffed arm motion-free and relaxed without any muscle tension in the biceps and triceps during the measurement.
- Does not cross his/her legs for the measurement.

Keep aware of current practices as recommended by the American Heart Association, British Hypertension Society, and other medical practice associations.

1. Ready the patient into a sitting  , standing  , or supine  position.
Remember that a patient's BP can vary with position.



The stress of being in a clinical situation often causes patients to undergo 'white coat hypertension,' leading to higher-than-normal readings. Help your patient to relax as you prepare to take the measurement.

Selecting the Right Cuff

Your device comes with durable two-piece All Purpose Cuffs (APC) from *ADC*. Cuffs are available in a range of sizes, from *Child* to *Thigh*. Note that your *ADview* works optimally with APC cuffs.

Using the table below, select a cuff you estimate to be of the right circumference:

	Child / 12-19cm
	Small Adult / 17-25cm
	Adult / 23-33cm
	Large Adult / 31-40cm
	Thigh / 38-50cm

2. Wrap the cuff around the patient's upper arm midway between the elbow and the shoulder.
3. Ensure the **ARTERY** arrow is over the brachial artery, between the biceps and triceps muscles on the inside of the arm.
4. Use the range indicator  and the **INDEX** line on the inside of the cuff to check that the arm circumference falls within the specified range of the cuff. If the arm is within range, this cuff size is correct for your patient. If the measurement is outside the **RANGE** indicator, use the appropriate larger or smaller cuff and re-check.



Using a cuff that is too small, commonly called undercuffing, can result in overestimating a patient's BP. Using a cuff that is too large, or overcuffing, can result in underestimating a patient's BP. For most accurate results, take care in selecting the appropriate size cuff for your patient.

5. Ensure that the BP pressure hose is connected to the cuff. Confirm that the hose is neither compressed nor kinked.
6. Ask the patient to stay still and quiet before taking the measurement.



Do not place the cuff on an arm currently being used for other procedures such as intravenous infusions or oximetry readings.

Taking a Measurement

The *ADview* allows you to take BP measurements automatically like a monitor or manually like a sphygmomanometer using manual Sphygmode™.

In automatic mode, the cuff inflates and deflates automatically. Initial inflation reaches a cuff pressure of 160 mmHg; the cuff then re-inflates as necessary to obtain a reading. Deflation is optimized to reduce measurement time and obtain an accurate result.

In manual *Sphygmode*, you inflate the cuff manually using the *Sphygmode* MAN button in place of an inflation bulb of a sphygmomanometer. When you release the *Sphygmode* MAN button, the cuff automatically deflates at the AHA recommended rate of 3mmHg/sec. Simply use your stethoscope to determine your patient's blood pressure.

Taking an Automated Measurement

1. With the patient prepped as described earlier (page 20), and the device powered on, depress the automatic button that is located in front of the BP module and denoted



by the cuffed arm icon . The cuff inflates to approximately 160 mmHg, as indicated in the systolic area of the display.

2. Once the cuff pressure reaches its target, the device controls the deflation and, in some instances, re-inflation of the cuff in order to accurately measure BP. The cuff pressure displays in the systolic area and is also indicated by the vertical LED bar to the left. When you hear a single short beep, indicating the end of the measurement cycle, read the systolic and diastolic pressures, displayed under the SYS and DIA symbols, and the pulse rate, displayed under the /min symbol.



Want a MAP reading?

NOTE: MAP available outside USA only

By default, your *ADview* measures systolic and diastolic BP, and HR. To obtain a Mean Arterial Pressure (MAP) reading, hold down the Sphygmode

manual button  as you toggle power to *on*. On power up, the MAP icon lights up on the LED display. Now, once measurements are complete, the display will alternate between HR and MAP. To exit MAP mode, power the

device off and again hold down the Sphygmode manual button  as you toggle power to *on*. On power up, the MAP icon will flash and disappear. MAP will no longer be displayed.

3. If there is an error in obtaining a measurement, indicated by three beeps, please refer to the troubleshooting tips on page 42 and take the appropriate remedial measure.



Taking a measurement on each arm helps rule out dissecting aneurysms, coarctation of the aorta, vascular obstruction and possible errors in measurement.¹

You can find more tips like this in the American Heart Association's current scientific statement on recommendations for blood pressure measurement.

Taking a Manual Sphygmode Measurement

1. With the patient prepped as described earlier (page 20), and the device powered on, palpate the brachial artery at the antecubital fossa. Place your stethoscope over this space.
2. Press and hold the Sphygmode manual button  until you inflate the cuff to a level at least 30 mmHg higher than the patient's systolic pressure.
3. Once the cuff has been inflated to the desired level, release the Sphygmode manual button. The cuff begins to deflate at approximately 3mmHg/sec and the device displays the cuff pressure.
4. While listening to your stethoscope, note the systolic and diastolic pressures corresponding to the first and last Korotkoff sounds (K-sounds) heard.



Press the Sphygmode manual button  to re-inflate the cuff.

Press the automatic button  if you need to rapidly release all the air from the cuff.

¹ Circulation. AHA Scientific Statement: Recommendations for Blood Pressure Measurement in Humans and Experimental Animals, Part 1: Blood Pressure Measurement in Humans: A Statement for Professionals From the Subcommittee of Professional and Public Education of the American Heart Associations Council on High Blood Pressure Research. Thomas G. Pickering, MD, DPhil; John E. Hall, PhD; Lawrence J. Appel, MD; Bonita E. Falkner, MD; John Graves, MD; Martha N. Hill, RN, PhD; Daniel W. Jones, MD; Theodore Kurtz, MD; Sheldon G. Sheps, MD; Edward J. Roccella, PhD, MPH, 2005;111:697-716.

K-Sounds: A Primer

Korotkoff sounds, commonly called K-sounds, are the sounds you detect through your stethoscope when you measure blood pressure with a sphygmomanometer or an aneroid device. Named for the Russian physician who identified them, there are five phases of K-sounds, each phase characterized by a distinct volume and quality of sound.

K-sounds are heard through the stethoscope as the blood pressure cuff deflates. The first sound, K-1, is heard when cuff pressure equals systolic pressure. K-1 is a sharp, tapping sound.

The K-2 phase is characterized by a swishing sound, caused by the swirling currents in the blood as the flow through the artery increases.

In the K-3 phase, there is a resumption of crisp tapping sounds, similar to those heard during phase 1.

An abrupt muffling of sound identifies K-4, the fourth phase.

The end or fifth phase is the point at which sounds cease to be heard altogether.

Systolic pressure is registered at K-1 and diastolic at K-5.



K-4 or K-5? There exists some debate about whether K-4 or K-5 should be recorded as the diastolic BP. In most cases, K-5 is preferred. However, if the sound persists even after the cuff is completely deflated, it is recommended that K-4 be recorded as the diastolic blood pressure.²

You can find more tips like this in the British Hypertension Society's current guidelines for management of hypertension.

² B Williams, NR Poulter, MJ Brown, M Davis, GT McInnes, JF Potter, PS Sever, S McG Thom, British Hypertension Society Guidelines, Guidelines for management of hypertension: report of the fourth working party of the British Hypertension Society 2004 – BHS IV, Journal of Human Hypertension, 2004 18, 139-185.

MEASURING TEMPERATURE WITH THE *ADVIEW*

Your *ADview* device can measure temperature with the optional temperature module. This module enables you to take rapid, accurate temperature measurements ranging from 86°F-109.4°F. Typically, predictive readings are obtained within ten to fifteen seconds, and direct readings within two minutes. The module is equipped with the temperature probe for oral/axillary measurement, color-coded blue. A rectal probe that is color-coded red is optionally available.

Temperature Units of Measurement

The device displays the temperature measurement in:

- Celsius
- Fahrenheit

To choose a unit of measurement, depress the recessed button on the left side of the temperature module. The icon for the selected unit is illuminated. This is now the default selection.

Temperature Measurement Modes

The device can measure temperature via three modes:

- Oral, indicated by *ORL* on the display and measured using the blue probe
- Axillary, indicated by *AXL* on the display and measured using the blue probe
- Rectal, indicated by *REC* on the display and measured using the red probe

All three modes can be used for both predictive and direct measurement. In the default predictive mode, your *ADview* predicts temperature in 10-15 seconds with an accuracy of +/- 0.2 °F (+/- 0.1°C). When a fever is detected, the measurement may last longer. In direct mode, the display continually updates until a stable reading is reached. This mode is used in certain difficult conditions when a predictive reading is not preferred or possible.



Axillary and rectal modes are preferred for children and compromised patients.

Using temperature probe and probe covers

In addition to the safety instructions for your *ADview*, here are some additional tips on using the probe and probe covers for the optional temperature module:

- Use only *ADC* by SunTech supplied probe covers with this device.
- The device and probe covers are non-sterile. Do not use on abraded tissue.

- To limit cross contamination, use blue probes for taking oral and axillary temperature only. Use red probes for rectal temperatures only.
- Dispose used probe covers in accordance with current medical practices or local regulations regarding disposal of infectious, biological medical waste.
- Note that proper placement of the probe is essential to the accuracy of the measurement.

Taking an Oral Temperature

1. Remove the blue probe from its holder and secure a disposable cover on it. The probe pre-heating process begins with the flashing display of the type of measurement, **orL**.
2. After a few seconds, the device will beep to signify that the probe is ready for placement. After the beep, place the probe carefully under the patient's tongue as denoted by the heat pockets shown to the right. The posterior medial sublingual pocket is preferred for accuracy. Hold the probe in place so that its tip maintains tissue contact. Close the patient's mouth. During measurement, a "traveling dash"  is displayed.
3. After 10-15 seconds, a long beep signals the end of the measurement cycle. The temperature will display for two minutes or until you initiate a new measurement.
4. Remove the probe from the patient, discard the probe cover by pressing the end of the probe handle, and return the probe to the probe holder. Note the temperature reading.

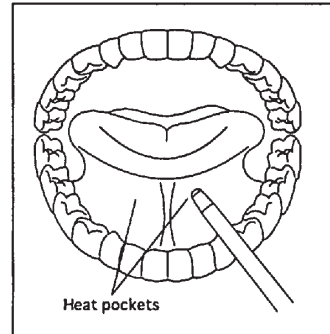

By default, the predictive method is selected. To select direct measurement from the start, press the temperature mode select button located on left side of the temperature module for three seconds or until you hear two short, quick beeps. When using direct measurement, the display will alternate displaying "dir" and the current probe temperature. A long beep signals the final temperature result.

Taking an Axillary Temperature

1. Remove the blue probe from its holder and secure a disposable cover on it. The probe pre-heating process begins with the flashing display of the type of measurement, **orL**.

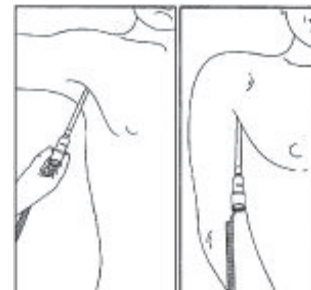

2. Briefly (less than 2 seconds) press the temperature mode select button until it displays **ax** for axillary.
3. After a few seconds, the device will beep to signify that the probe is ready for placement. After the beep, lift the patient's upper arm and place the probe high under the patient's axilla. Apply pressure gently to assure good contact between the probe and axilla, and make sure there is no interference such as clothing. Hold the probe in place so that its tip maintains tissue contact. Place the arm by the patient's side. During measurement, a "traveling dash"  is displayed.



Note that proper placement of the probe is essential to the accuracy of the measurement.

4. After 10-15 seconds, a long beep signals the end of the measurement cycle. The temperature will display for two minutes or until you initiate a new measurement.
5. Remove the probe, discard the probe cover and place back in the probe holder. Note the temperature reading.

Taking a Rectal Temperature

1. Remove the blue probe and well by sliding the pieces upward until they detach.
2. Place the red probe in the holder of the red well and the probe connector in the notched space as shown to the right (see page 38 for detailed instructions). Slide the red well vertically onto the back of the module thus replacing the blue well.
3. Assist patient into a prone (facedown) position and ensure that the patient is relaxed.
4. Remove the red probe from its holder and secure a disposable cover on it. The probe pre-heating process begins with the flashing display of **rec**.
5. After a few seconds, the device will beep to signify that the probe is ready for placement. After the beep, separate the patient's buttocks and apply a thin coat of water-based lubricant for smooth entry of the probe. Insert the probe gently 1 cm inside the sphincter. Tilt the probe to keep it in place and hold it in position to ensure tissue contact. During measurement, a "traveling dash"  is displayed.

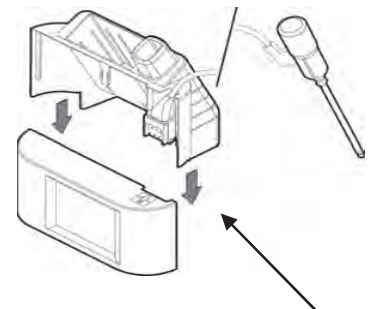

Notched space/Probe connector



Note that proper placement of the probe is essential to the accuracy of the measurement.

-
6. After 10-15 seconds, a long beep signals the end of the measurement. The result will be displayed for two minutes or until you initiate a new measurement.
 7. Remove the probe, discard the probe cover and place back in the probe holder. Note the reading.



If the temperature reading is out of range, the device will beep and flash the limit that is exceeded. So, if the reading is greater than 109.4°F (43.0°C), “109.4” or “43.0” will flash on the display followed by a sequence of rising LED’s. If the reading is less than 86.0°F (30.0°C), “86.0” or “30.0” will flash on the display followed by a sequence of falling LED’s.

MEASURING OXYGEN SATURATION WITH THE *ADVIEW*

The *ADview* optional pulse oximeter module measures functional oxygen saturation ranging from 40% to 100%. A signal strength display assists the clinician in the proper placement of the sensor.



The *ADview* is a spot check device and is not used for patient monitoring. Therefore, there are no SpO₂ alarms.

Steps for measuring functional oxygen saturation:

- Prepping the patient and affixing the sensor
- Taking a reading

Prepping the Patient

Selecting the Right Sensor

Your choice of sensor is affected by many factors including:

- Patient's body weight
 - Patient activity
 - Infection control concerns
-



For most patients greater than 30kg, use an adult sensor; for patients 10-50kg, a pediatric sensor may provide better fit.

Protecting Your Pulse Oximetry Sensors

In addition to the safety instructions for your *ADview*, here are some additional tips on caring for the sensor of the optional pulse oximetry module:

- To prevent damage, do not autoclave or immerse the sensor in liquid.
- For peak performance and accurate measurements, do not expose the sensor to excessive ambient light, electromagnetic interference, dysfunctional hemoglobin, low perfusion, intravascular dyes, finger nail polish and long or artificial finger nails.
- Do not use a damaged sensor as it may cause patient injury or equipment failure.
- The use of this sensor is contraindicated in patients with allergies to adhesive tape.

Guidelines for Use

- When selecting a sensor site, give priority to an extremity free of an arterial catheter, blood pressure cuff or intravascular infusion line.
- Clean reusable sensors after use.
- Ensure that the optical components of the sensor are properly affixed to the patient and aligned.
- Artificial nails, or dark shades of nail polish, may reduce light transmissions and affect pulse oximetry accuracy. Clean off nail polish or detach artificial nails before applying the sensors.
- Secure sensor cable firmly but lightly at the base of the finger.
- Inspect the sensor application site at least every 6 to 8 hours to ensure correct sensor alignment and skin integrity. Patient sensitivity may vary due to medical status or skin condition. Discontinue use of adhesive tape strips if the patient exhibits an allergic reaction to the adhesive materials.

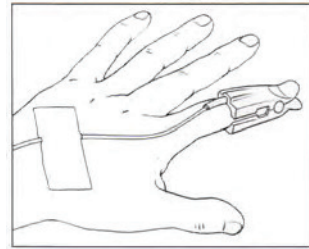



Measuring Oxygen Saturation with Sensor on Finger

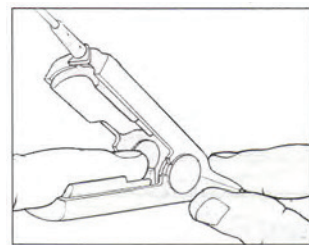

For best results, clip the sensor on the index, middle or ring finger, avoiding the little finger or thumb.

1. For the reusable finger sensor, insert the patient's digit, index most preferable, into the sensor. Ensure that the tip of the digit touches the rear guide posts of the sensor and the sensor cable extends along the top of the patient's hand. Secure sensor with wrap, tape or bandage.



SpO₂ measurement will begin automatically. Once the SpO₂ determination begins, a “traveling dash”  will be displayed until a measurement is determined, usually in 10 seconds. This reading will be updated once per second. SpO₂ can be measured without interruption for up to 10 minutes. Along with the functional oxygen saturation value, the signal strength will also display.

2. When you remove the sensor from the patient's finger, the display will flash the last measurement for 8 seconds. The measurement will then be displayed for 2 minutes or until another measurement is made. Note the patient's reading and confirm normal venous return.



After 10 minutes of continuous measurement, the measurement is automatically terminated and status code "01" is displayed. To view the last measurement prior to automatic termination, press and hold the



automatic button for more than two seconds (see page 32 for details).

MANAGING READINGS

Recalling the Last Set of Readings



To redisplay the last set of readings, depress the automatic button on the BP module for more than two seconds until the last reading is displayed. If your *ADview* has temperature and/or pulse oximetry modules, the last set of readings includes these readings as well. If the last attempted reading resulted in an error and/or warning, then this will be displayed. The device will display dashes if no reading is in memory, a reading was aborted or, the previous BP was a Sphygmode measurement.

For the pulse oximetry module: In the event of the 10-minute measurement timeout, the module will terminate the measurement and status code “01” will display on the main module. The last valid reading recorded at the end of the ten-minute period will be the recalled reading.

Clearing the Last Set of Readings

To clear the values from the last automatic BP measurement and the accessories, press and



hold the automatic button more than 5 seconds. Previous values will be displayed momentarily. Then the display blanks. On redisplay you will see dashes for all the values that have been cleared.



Your *ADview* displays the most recent set of readings for two minutes. If patient privacy is a concern, you can clear these readings from the display before collecting vital signs from another patient.

Bluetooth Wireless Transmission of Readings

If your *ADview* has the optional Bluetooth wireless communication capability you may be able to transmit the readings into your EMR/EHR system or communication network. Contact your IT administrator or EMR/EHR vendor for support on configuring your *ADview* for Bluetooth wireless communication.

MAINTAINING THE *ADVIEW*

Routine Maintenance

Establishing simple care guidelines helps protect the performance and life of your *ADview*. On a routine basis, you should inspect the device, cables and pneumatic hoses for cracks, fraying or kinks and immediately replace any damaged parts.

Remember to check the calibration of the BP module annually. If available, a biomedical technician may help in maintaining your equipment.

Cleaning

Cleaning the Device

1. Wipe the device with a soft, damp cloth to remove surface dust and dirt.
- 2.



The *ADview* device cannot be sterilized.



Never immerse the device in any fluid or attempt to employ cleaning fluids or solvents.

Cleaning the Cuffs

1. Between uses, wipe cuff sleeves and the insides of cuffs with a medical grade cleaning agent.
2. Periodically, remove the bladders and machine-wash the cuffs in cold water.
3. Line dry.

Cleaning the SpO₂ Sensor

1. Clean sensor and clips with a soft cloth dampened with water, a mild soap solution, or isopropyl alcohol.
2. Remove all tape residues by rubbing off.

3. Dry sensor and clips thoroughly before re-use.
- 4.



Never immerse sensor and clips in fluids. Do not pour or spray any liquids on them either. Caustic or abrasive cleaners will cause permanent damage.





Prying the finger clip sensor to an angle greater than 90° can permanently damage its casing.

Checking the Calibration of Your Device

It is recommended that you check the BP calibration of your *ADview* once a year. To check calibration:

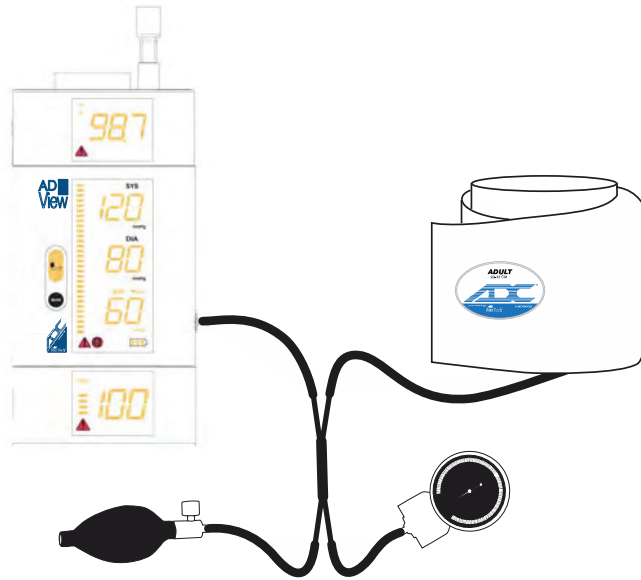
1. Start with the device powered off. While holding down the automatic button  on the front of the BP module, toggle on the power button on the right side of the main enclosure. The “CAL” message is displayed in the pulse rate display to indicate that the system is in the calibration mode. During this mode, the system pressure displays in the systolic BP display area.
2. Using a set of two T-connectors, connect a calibrated pressure reference and control, such as a manometer of known accuracy, and inflation bulb, to the pressure hose connector of the *ADview*. Contact ADC customer support for details on ordering the calibration kit which includes a T-connector. The diagram below shows how these four components should be connected.



3. Compare the pressure reference to the *ADview* throughout the pressure range, 0 to 270mmHg. If the difference between the pressure reference and the *ADview* is no larger than 2mmHg, the *ADview* is calibrated correctly for operation. If the *ADview* needs calibrating, contact an authorized service center on page 48.
4. Exit the calibration check by pressing the automatic button  again. Once the display shows dashes as the systolic BP, you are now ready to take a measurement.

It is recommended that you check the temperature calibration of your *ADview* temperature module annually. A Calibration Plug (part# 9000TCP) is available to check accuracy of the technology. It replaces the regular probe and verifies the accuracy of the temperature electronics. Replace the temperature module if error is greater than $\pm 0.1^{\circ}\text{C}$. To check the calibration:

1. Remove the Temperature Well from the Temperature Module.
2. Replace the Temperature Probe with the Calibration Plug.
3. Replace the Temperature Well.
4. Initiate a measurement by inserting and removing the Temperature probe from the well.
5. Verify the accuracy of the measurement.

Probe accuracy can be checked by using the thermometer as you would on a patient in any mode with a cover, but place it in a calibrated water bath. Direct mode is accurate to $\pm 0.1^{\circ}\text{C}$ of the calibrated water bath temperature. Predictive mode accuracy is accurate to $\pm 0.2^{\circ}\text{C}$ of the calibrated water bath temperature.

Replacing the Rechargeable Battery

Replace the battery:

- According to your regular maintenance schedule.
- When the battery no longer charges.
- After heavy use, if necessary.

To replace the battery:

1. Remove the four screws securing the battery bay door.
2. Carefully remove the battery from the battery bay, being careful not to pull on the wires attached to the battery terminals.
3. Disconnect the wires from the battery terminals.
4. The rechargeable battery contains lead. Please dispose of the old battery properly.
5. Connect the wires to the terminals of the replacement battery, ensuring the red wire is attached to the red terminal and the black wire to the black terminal. If the wires are reversed, no damage will occur, however the *ADview* will not operate. Be sure to use *ADC* item number 9000BAT for the replacement battery in order to maintain optimum performance.
6. Re-secure the battery bay door with the four screws removed in step 1.
7. Connect the power supply to turn the device on and charge the replacement battery fully before using.



If the rechargeable battery is disconnected for any reason, the device must be connected to AC mains power via the power supply before the unit will turn on; this is required even if the battery has been properly reconnected.

Disposal



This symbol indicates the device contains materials (such as electrical components) which are hazardous. Please return to *ADC* for disposal.

Attaching the Temperature Module

Should you need to attach or remove the temperature module; the following instructions give an overview of its attachment to the BP module. The temperature module attaches to the top of the BP module. It is made up of the following two pieces:

- Part A with the display.

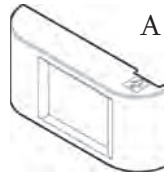

- Part B, the probe holder, which holds the temperature probe and probe cover box.

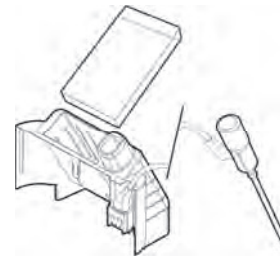

1. Using the power button on the right side of the BP module, ensure that the *ADview* is off.
2. Remove the cover plate from the top of the BP module.

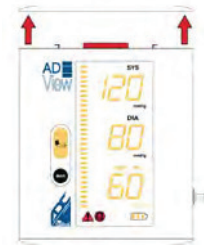

3. Slide part A of the temperature module along the guides on the top of the BP module from front to back until it snaps into place. All the segments of the temperature module display will light when the modules have been connected correctly.

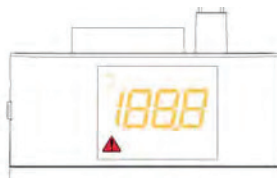
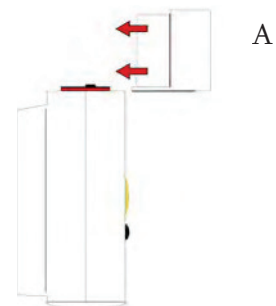

- Attach the temperature probe connector to part B as follows: with the black surface facing downward, hold the probe connector end against the notches on the probe holder, as shown in red (step 1 shown below).

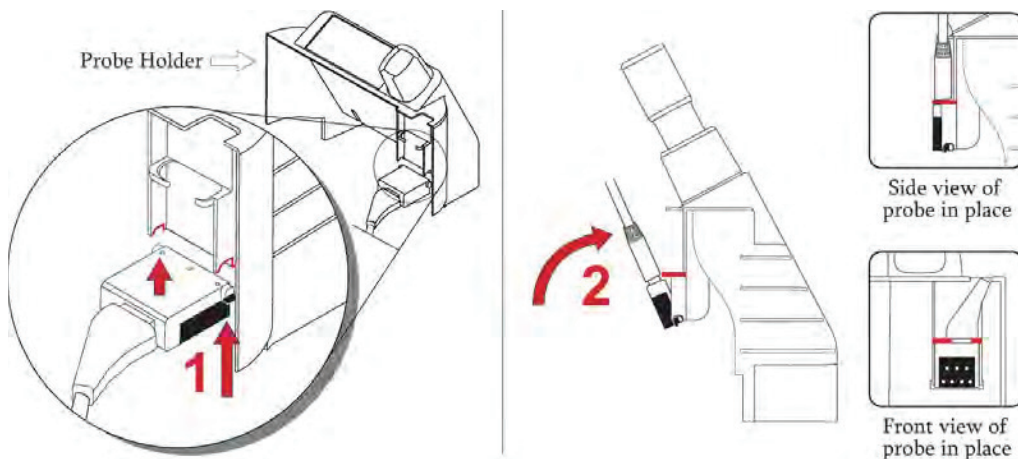

- Rotate the connector upwards until it snaps securely into place (step 2 shown above). The black surface faces outward and the cord extends upward.
- Slide part B onto part A as shown (this connects the temperature probe connector to the temperature unit connector), and insert the temperature probe into the well.
- Turn the device on using the power button on the right side of the BP module. At the end of the start-up sequence, the temperature module display will be blank except for the appropriate temperature unit icon ($^{\circ}\text{F}$ or $^{\circ}\text{C}$). A short beep indicates that the *ADview* is ready.

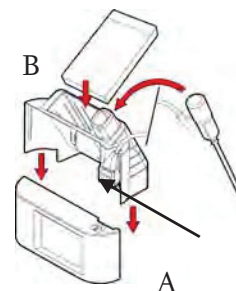

Note: If the temperature module does not appear to be working properly, cycle the power several times using the power button on the right side of the BP module. This will “synchronize” all the modules. The modules are synchronized when, after you turn the power on, all segments on all module displays light simultaneously for 3 to 5 seconds, followed by a short beep, and all displays go to their “ready” state (BP: battery icon and middle segments of the systolic value are lit; Temperature: appropriate temperature units icon is lit; Pulse Oximetry: the “%SpO₂” icon is lit).

Temperature unit connector (not shown)

Attaching the Pulse Oximeter Module

Should you need to attach or remove the pulse oximetry module; the following instructions give bottom of the BP module.

- Using the power button on the right side of the BP module, ensure that the *ADview* is off.
- Remove the cover plate from the bottom of the main BP module.

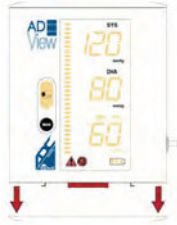

3. Slide the pulse oximetry module along the guides on the bottom of the main BP module from front to back until it snaps into place. All the segments of the pulse oximetry module display will light when the modules have been connected correctly.



4. Turn the device on using the power button on the right side of the BP module. At the end of the start-up sequence, the pulse oximetry module display will be blank except for the “%SpO2” symbol.

5. Turn the device off. Connect the adult 10’ reusable sensor cable to the connector on the module. Secure the cable to your device using the retention clip.

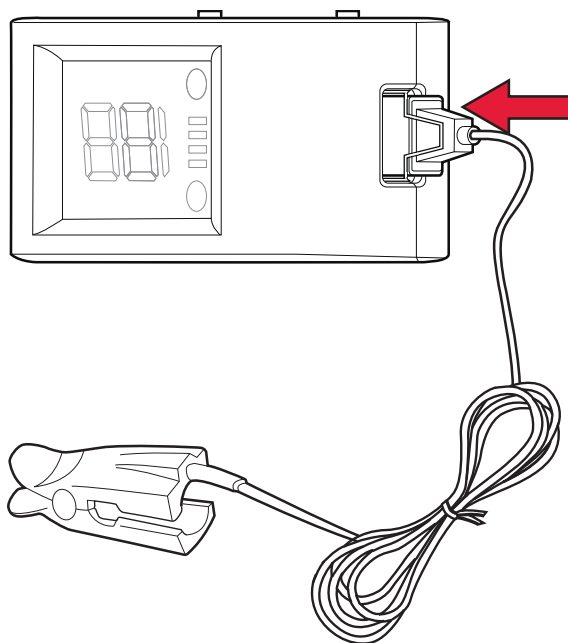

5. Turn the device on. All display segments light up for three to five seconds. A short beep indicates that the *ADview* is ready.

Note: If the pulse oximetry module does not appear to be working properly, cycle the power several times using the power button on the right side of the BP module. This will “synchronize” all the modules. The modules are synchronized when, after you turn the power on, all segments on all module displays light simultaneously for 3 to 5 seconds, followed by a short beep, and all displays go to their “ready” state (BP: battery icon and middle segments of the systolic value are lit; Temperature: appropriate temperature units icon is lit; Pulse Oximetry: the “%SpO2” icon is lit).

Storage, Shutdown, Transport

Storage

The *ADview* must be stored between -20°C (-4°F) and 55°C (131°F). Relative humidity must be less than 90%.

If you are storing the *ADview* Battery for 30 days or longer, it is recommended that you disconnect the battery from the device.

Moving Your Device

To pack your device for repair or transport:

1. Detach the cuff, temperature probe, SpO₂ sensor, power supply, and other ancillary products from the device.
2. Disconnect the battery and remove it from the device.
3. Place the device in the original shipping carton, preferably with its original packing material.
4. Ensure that the device will be kept at between -20°C (-4°F) and 55°C (131°F) and in relative humidity less than 90% during transshipment.

TROUBLESHOOTING

The troubleshooting chart provides pointers on diagnosing issues associated with error or status codes.



Problem: The *ADview* will not power on.

Solutions:

1. The *ADview* must be plugged in to charge before first use.



Problem: My *ADview* is not communicating with my EMR/EHR system or network

Solutions:

1. Be sure your *ADview* is equipped with the Bluetooth option.
2. Your *ADview* and wireless system must be configured to communicate. Refer to your EMR/EHR operator's manual or contact your IT administrator or EMR/EHR provider.
3. You may need to move your *ADview* closer to the wireless system. While the Bluetooth capability on the *ADview* has been rated up to a maximum range of 100 m, be sure to minimize walls, structures and other obstacles that may impede wireless connectivity.

Troubleshooting – Blood Pressure Module



Problem: Wrong size cuff, Misplaced cuff, or Blocked brachial artery

Solutions:

1. Check that the cuff is in the correct position.
2. Check that the cuff is properly tightened.
3. Check that there is no excessive clothing between the arm and the cuff.
4. Check that the cuff applied is of the correct size.
5. The patient may have been moving too much.
6. Take another BP reading.



Problem: Too much patient or environment motion or conditions causing tremors

Solutions:

1. Check that the cuff is in the correct position.
2. The patient may have been moving too much.
3. Take another BP reading.



Problem: Air leak, Loose cuff, or Blocked or pinched hose

Solutions:

1. Check that the hose has no sharp bends or is pinched.
2. Check that the patient is not lying on the cuff.
3. Check that the cuff is in the correct position.
4. Check that the hose is connected to the system and the cuff.
5. Check that the cuff is properly tightened.
6. Check that the correct size cuff is being applied.
7. Check that the cuff is not leaking air.
8. Check that the hose connections are not damaged or loose.
9. Take another BP reading.



Status Codes: 800, 900, 910, 970, 980, or 990

Problem: System error

Solutions:

1. Take another measurement.
2. If this is unsuccessful, power down, then power up the unit using the power button on the right side of the unit. If the error does not recur immediately, take another measurement.
3. If the error recurs, remove power from the unit (unplug any power supplies and remove the battery, then reconnect the power. If the error does not recur immediately, take another measurement.
4. If the error recurs, contact *ADC* or an authorized service center.

Troubleshooting – Temperature Module



Status Code: 5

Problem: Temperature probe missing or outside of well

Solutions:

1. Remove and then place the probe in the well.
2. Ensure that the temperature well (the rear portion of the temperature module) is well seated on the display. Along the top of the module, the edge of the well should be flush with the display. Remove and carefully slide the well onto the display.

When properly fixed, the error should no longer be displayed. Take a new measurement.



Status Code: 10

Problem: Defective temperature probe

Solutions:

1. Remove and then place the probe in the well.
2. Ensure that the temperature well (the rear portion of the temperature module) is well seated on the display. Along the top of the module, the edge of the well should be flush with the display. Remove and carefully slide the well onto the display.

When properly fixed, the error should no longer be displayed. Turn the device off. After it has shut down, turn it on. The error should no longer be displayed. Take a new measurement.



Status Code: 15

Problem: Stuck button

Solution: Depress the Temperature units select button and/or the Temperature mode select button until the button becomes unstuck. When the button is unstuck, the error will no longer be displayed. If you cannot un-stick the button, contact *ADC* or an authorized service center.



Status Code: 20

Problem: Hardware error

Solutions:

1. Take another measurement.
2. If this is unsuccessful, power down, then power up the unit using the power button on the right side of the unit. If the error does not recur immediately, take another measurement.
3. If the error recurs, remove power from the unit (unplug any power supplies and remove the battery), then reconnect the power. If the error does not recur immediately, take another measurement.
4. If the error recurs, contact *ADC* or an authorized service center.

Troubleshooting – Pulse Oximetry Module



Status Code: 01

Problem: Measurement time-out. The measurement time exceeded the 10-minute time limit.

Solution: Remove the sensor from the patient. Redisplay the last measurement prior to the timeout, or take a new measurement by placing the sensor on the patient.



Status Code: 02

Problem: Poor sensor position (signal is inadequate for a reliable measurement)

Solution: Adjust position of sensor on patient by placing sensor on opposite hand or ear or alternate site. Avoid fingers with nail polish or artificial nails.



Status Code: 05

Problem: The sensor has been disconnected from the device.

Solution: Reconnect the sensor. If you wish, you may leave the sensor disconnected as this code is only displayed once at the time the sensor is disconnected.



Status Code: 10

Problem: Defective sensor

Solution: Replace the sensor and take a new measurement.



Status Code: 20

Problem: Hardware error

Solutions:

1. Take another measurement.
2. If this is unsuccessful, power down, then power up the unit using the power button on the right side of the unit. If the error does not recur immediately, take another measurement.
3. If the error recurs, remove power from the unit (unplug any power supplies and remove the battery), then reconnect the power. If the error does not recur immediately, take another measurement.
4. If the error recurs, contact *ADC* or an authorized service center.



Problem: Inadequate signal strength

Solution: If there is no measurement and the signal quality is low, try a different site or sensor. Avoid fingers with nail polish or artificial nails. If there is no improvement in signal quality, then discontinue use.

FAQs

Can I obtain replacement copies of the *ADview* CD and manual?

Copies of the *ADview* manual are available through the Customer Service area of our website. To download the manual, please visit www.adctoday.com/adview. For a replacement CD, please email Customer Service at info@adctoday.com

How do I clean the *ADview* device?

The *ADview* requires only minimal cleaning. Wipe it down occasionally with a soft, damp cloth. Never immerse the device or apply cleaning fluid or solvents.

How do I install the rechargeable battery in the *ADview*?

Remove the battery bay cover and position the rechargeable battery within, ensuring proper alignment of polarities. Replace the cover securely and connect the device to AC mains power via the power supply to turn the device on. Ensure the battery is fully charged before use. (See page 36 for detailed instructions.)

How often should I calibrate the BP Module for the *ADview*?

You should check the calibration once a year. If there is a difference larger than 2 mmHg against the pressure reference, then contact an authorized service center on page 46.

How accurate is the *ADview* blood pressure device?

The *ADview*, designed for accuracy, has been manufactured to comply with AAMI SP10 protocol, and has been independently validated to both the British Hypertension Society (BHS) and European Society of Hypertension (ESH) standards for clinical accuracy.

What method of blood pressure measurement is used in the *ADview*?

The *ADview* takes automated BP measurements using the oscillometric method. It supplements this with the ability to take measurements as you would if you were using a mechanical sphygmomanometer.

Can I upgrade my current version of *ADview* at a later date?

To upgrade your *ADview* device, please review the list of accessories starting on page 63 or on our website. Contact your local distributor for details.

Could I use the *ADview* to measure blood pressure during a stress test?

Although your *ADview* is a robust device that has been manufactured with motion tolerance, it is not intended for use during stress testing.

Should I wait between temperature measurements?

Yes. Accurate temperature measurement requires the probe to be at normal room temperature. After taking a measurement, wait for the probe to return to room temperature or wipe the probe with an alcohol wipe before taking a subsequent measurement.

Do I need to calibrate the temperature or pulse oximetry modules?

For calibration or service on the *ADview* temperature and pulse oximeter modules, contact an authorized service center on pages 47-48.

How accurately does the *ADview* temperature module measure temperature?

The *ADview* temperature module is accurate to ± 0.2 °F (± 0.1 °C).

What is the accuracy of the *ADview* pulse oximetry module?

The *ADview* pulse oximetry module is $\pm 2\%$ in the 70 to 100% range for no motion and normal perfusion. For motion or low perfusion, the accuracy is $\pm 3\%$.

When does the warranty period begin?

The warranty for your *ADview* begins on the date of shipment of your device.

How do I make a warranty claim for the *ADview*?

Contact an authorized service center on pages 47 - 48.

How do I get my *ADview* to communicate with my EMR/EHR software system?

You must have the optional Bluetooth capability to allow communication with any EMR/EHR system. Please contact your IT administrator or EMR/EHR system provider about configuring your *ADview* for communication. Software development kits are available from ADC for EMR/EHR vendors to support communication with the *ADview*.

Web Resources

www.adctoday.com/adview

Service Centers

For customers in the Americas

ADC by SunTech
Service Department
55 Commerce Drive
Hauppauge, NY 11788
USA
Tel: 631.273.9600
Fax: 631.273.9659

For customers in Europe, the Middle East, and Africa

SunTech Medical Inc., Ltd.

Oakfield Estate

Eynsham, Oxfordshire

England

Tel: +44 (0) 1865.884.234

Fax: +44 (0) 1865.884.235

For customers in Asia and the Pacific

SunTech Medical Inc., Ltd.

Level 19, Two, International Finance Centre

8, Finance Street, Central

Hong Kong

Tel: +852.2251.1949

Fax: +852.2251.1950

SPECIAL SITUATIONS

Special Situations

Unique circumstances, such as the patient's age or physiological disturbances, require you to take special care while measuring blood pressure or vital signs. The more common examples of such circumstances are described here, to assist you in using your *ADview* optimally under such conditions. You can find recommendations on dealing with each of these special situations in the American Heart Association's current scientific statement on recommendations for blood pressure measurement or the British Hypertension Society's current guidelines for management of hypertension.

Measuring Blood Pressure in Children

Typically, children exhibit greater variability in blood pressure than do adults. They are more likely to be crying, eating or restless in a clinical situation, further increasing the potential for variability.

Measuring Blood Pressure in Obese Patients

There appears to be a positive correlation between obesity and hypertension. Due to the increased arm circumference of obese patients, use of a "standard" cuff may lead to blood pressure being erroneously elevated – a condition known as "cuff hypertension."

Selecting an Appropriate Cuff for Obese Patients:

- For larger-than-normal upper arms, use a wider and longer cuff than you would otherwise use.
- Prominent biceps in a muscular upper arm require a large cuff.

Measuring Blood Pressure in the Presence of Arrhythmia

Irregular cardiac rhythms can result in a large variation in blood pressure from beat-to-beat. If you are using the *ADview* on a patient with known arrhythmia, we recommend that you follow up with a Sphygmode BP reading as a confirmatory measure.

In patients with severe regular bradycardia, take Sphygmode rather than automatic readings.

Measuring Blood Pressure During Pregnancy

Hypertension is a common medical disorder of pregnancy, occurring in about ten percent of pregnancies. Detection of elevated blood pressure is essential to optimal prenatal care.

For clinically relevant hypertension in pregnancy, use the *ADview* to take a Sphygmode measurement.

Measuring Blood Pressure in the Elderly

In the elderly, the combination of hypertension and ageing can manifest as a decrease in arterial compliance. Variability in blood pressure can lead to a number of circadian blood pressure patterns that are best identified using ambulatory blood pressure measurement. The clinical consequence of this blood pressure variability is inaccurate readings.

Measuring Blood Pressure in the Emergency Room

Measuring blood pressure in the emergency room can be done through automated blood pressure measurements. For critically ill or injured patients, blood pressure should be measured through the invasive arterial pressure method.

Measuring Blood Pressure in the Presence of Orthostatic Hypotension

Orthostatic hypotension is defined as a decrease in systolic blood pressure of 20 mmHg or more or diastolic blood pressure of 10 mmHg or more measured after three minutes of standing up from a supine position. Food ingestion, time of day, age, and hydration can impact this form of hypotension, as can a history of Parkinsonism, diabetes, or multiple myeloma.

APPENDICES

Specifications

Patient population: Adult and pediatric patients (age 3 and above).

Method of measurement: Oscillometric

Initial inflation pressure: 160mmHg +/- 20mmHg

Blood pressure range (mmHg): 60< Systolic BP< 270, 30< Diastolic BP< 170

Blood pressure accuracy: Measurements determined with this device are equivalent to those obtained by a trained observer using the cuff/stethoscope auscultation method, within the limits prescribed by the American National Standard, *Manual, electronic or automated sphygmomanometers*.

Blood pressure determination time: 30-40 seconds typical for Adult cuff

Pulse rate range: 30-200 bpm +/- 2% or +/- 3 bpm, whichever is greater

Temperature range: 86°F (30.0°C) – 109.4°F (43.0°C)

Temperature accuracy: +/- 0.2°F (+/-0.1°C)

Functional oxygen saturation range: 40-100%

Functional oxygen saturation accuracy: 70-100% +/- 2 digits

(Note: because pulse oximeter equipment measurements are statistically distributed, only about two-thirds of pulse oximeter equipment measurements can be expected to fall within ± 2 digits of the value measured by a CO-oximeter.)

Operating conditions: 10°C (50°F) to 40°C (104°F) Less than 90% RH

Storage conditions: -20°C (-4°F) to 55°C (131°F) Less than 90% RH

Power: External power supply, AC adapter (*ADC* item number 9000AC9V)

Calibration: Check once per year for BP and Temperature

Safety systems: Independent hardware over-pressure circuit and redundant software overpressure algorithm to limit cuff pressure to less than 330 mmHg. Independent hardware timing circuit and redundant software timer algorithm to limit the duration of a blood pressure cycle to less than 180 seconds.

Dimensions: Length = 5.5 inches, Height = 11.5 inches, Width = 3.8 inches; Length =14.0 cm, Height = 29.2 cm, Width = 9.7 cm

Standards: UL60601-1, CAN/CSA C22.2 601-1

IEC 60601-1, IEC 60601-1-2 (EMC), IEC 60601-1-4, ISO 9919, AAMI SP10:2002, ASTM E 1112, EN 12470-3

Meets EN-1060-1, Specification for non-invasive sphygmomanometers – Part 1: General requirements and EN 1060-3, Non-invasive Sphygmomanometers – Part 3. Supplementary Requirements for Electro-Mechanical BP Measuring Systems”

Classification: Protection against electric shock: Internally Powered Equipment; Applied parts: Type BF; Mode of operation: Continuous

IP index: IPX0

Compliance

SunTech Medical Inc., Ltd.
Oakfield Industrial Estate
Eynsham, Oxfordshire OX29 4TS
UK
Tel: +44. 1865.884.234
Fax: +44. 1865.884.235

Safety Requirements

Clinical grade BP measurement accuracy defined by fully meeting the requirements of:

- AAMI SP-10 2002
- EN 1060-4

EMC Statement



This equipment has been tested and found to comply with the limits for medical devices to IEC60601-1-2: 2001. These limits are designed to provide reasonable protection against harmful interference in a typical medical installation. This equipment generates, uses, and can radiate radio frequency energy and, if not installed and used in accordance with the instructions, may cause harmful interference to other devices in the vicinity. This equipment should not be used adjacent to or stacked with other equipment. If this is necessary, the equipment should be observed to verify normal operation in the configuration in which it will be used. However, even if used properly, there is no guarantee that interference will not occur in a particular installation. If this equipment does cause harmful interference to other devices, which can be determined by turning the equipment off and on, the user is encouraged to try to correct the interference by one or more of the following measures:









- Reorient or relocate the receiving device
- Increase the separation between the equipment
- Connect the equipment into an outlet on a circuit different from that to which the other device(s) are connected
- Consult the manufacturer or field service technician for help

Use only *ADC*-approved cables and accessories with this device. Use of unauthorized cables or accessories may result in increased emissions or decreased immunity. Portable and mobile RF communications equipment can affect Medical Electrical Equipment.

Symbols

The following symbols are associated with the *ADview*:

SYMBOL	DESCRIPTION
	Manufactured by
	ETL certified
	Power supply contains materials which are hazardous. Must be disposed of properly.

SYMBOL	DESCRIPTION
	No SpO ₂ alarm
	Attention, consult accompanying documents.
	Class II isolation equipment
	CE approval
	Recognized component certified by UL to both Canada and US requirements
	TUV Canada and US approval
	TUV International approval
	Earth ground
	Output connection configuration – positive voltage; negative shield

Guidance and manufacturer's declaration – electromagnetic emissions		
The <i>ADview</i> is intended for use in the electromagnetic environment specified below. The customer or the user of the <i>ADview</i> should assure that it is used in such an environment.		
Emissions test	Compliance	Electromagnetic environment – guidance
RF emissions CISPR 11	Group 1	The <i>ADview</i> uses RF energy only for its internal function. Therefore, its RF emissions are very low and are not likely to cause any interference in nearby electronic equipment.
RF emissions CISPR 11	Class B	The <i>ADview</i> is suitable for use in all establishments, including domestic establishments and those directly connected to the public low-voltage power supply network that supplies buildings used for domestic purposes.
Harmonic emissions IEC 61000-3-2	Class A	
Voltage fluctuations/ flicker emissions IEC 61000-3-3	Complies	

Guidance and manufacturer's declaration – electromagnetic immunity

The *ADview* is intended for use in the electromagnetic environment specified below. The customer or the user of the *ADview* should assure that it is used in such an environment.

Immunity test	IEC 60601 test level	Compliance level	Electromagnetic environment – guidance
Electrostatic discharge (ESD) IEC 61000-4-2	±6 kV contact ±8 kV air	±6 kV contact ±8 kV air	Floors should be wood, concrete or ceramic tile. If floors are covered with synthetic material, the relative humidity should be at least 30%.
Electrical fast transient/burst IEC 61000-4-4	±2 kV for power supply ±1 kV for input/output lines	±2 kV for power supply ±1 kV for input/output lines	Mains power quality should be that of a typical commercial or hospital environment.
Surge IEC 61000-4-5	±1 kV differential mode ±2 kV common mode	±1 kV differential mode ±2 kV common mode	Mains power quality should be that of a typical commercial or hospital environment.
Voltage dips, short interruptions and voltage variations on power supply input lines IEC 61000-4-11	<5% U_T (>95% dip in U_T) for 0, 5 cycle 40% U_T (60% dip in U_T) for 5 cycles 70% U_T (30% dip in U_T) for 25 cycles <5% U_T (>95% dip in U_T) for 5 sec	<5% U_T (>95% dip in U_T) for 0, 5 cycle 40% U_T (60% dip in U_T) for 5 cycles 70% U_T (30% dip in U_T) for 25 cycles <5% U_T (>95% dip in U_T) for 5 sec	Mains power quality should be that of a typical commercial or hospital environment. If the user of the <i>ADview</i> requires continued operation during power mains interruptions, it is recommended that the <i>ADview</i> be powered from an uninterruptible power supply or a battery.
Power frequency (50/60 Hz) magnetic field IEC 61000-4-8	3 A/m	3 A/m	Power frequency magnetic fields should be at levels characteristic of a typical commercial or hospital environment.

NOTE U_T is the AC mains voltage prior to application of the test level

In the event of a power loss to the device, all user settings are saved. The device will power-up with the same settings as prior to the power loss. The device does not store patient data.

Guidance and manufacturer's declaration – electromagnetic immunity

The *ADview* device is intended for use in the electromagnetic environment specified below. The customer or the user of the *ADview* device should assure that it is used in such an environment.

Immunity test	IEC 60601 test level	Compliance level	Electromagnetic environment - guidance
Conducted RF IEC 61000-4-6	3 V _{rms} 150 kHz to 80 MHz	3V	Portable and mobile RF communications equipment should be used no closer to any part of the <i>ADview</i> , including cables, than the recommended separation distance calculated from the equation applicable to the frequency of the transmitter. Recommended separation distance $d = [3.5/V_1] \sqrt{P}$ $d = [3.5/E_1] \sqrt{P}$ 80MHz to 800MHz $d = [7/E_1] \sqrt{P}$ 800MHz to 2.5GHz where P is the maximum output power rating of the transmitter in watts (W) according to the transmitter manufacturer and d is the recommended separation distance in meters (m). Field strengths from fixed RF transmitters, as determined by an electromagnetic site survey ^a , should be less than the compliance level in each frequency range ^b . Interference may occur in the vicinity of equipment marked with the following symbol: 
Radiated RF IEC 61000-4-3	3V/m 80 MHz to 2.5 GHz	3 V/m	

NOTE 1—At 80 MHz and 800 MHz, the higher frequency range applies.

NOTE 2—These guidelines may not apply in all situations. Electromagnetic propagation is affected by absorption and reflection from structures, objects, and people.

^a Field strengths from fixed transmitters, such as base stations for radio (cellular/cordless) telephones and land mobile radios, amateur radio, AM and FM radio broadcast, and TV broadcast cannot be predicted theoretically with accuracy. To assess the electromagnetic environment due to fixed RF transmitters, an electromagnetic site survey should be considered. If the measured field strength in the location in which the *ADview* device is used exceeds the applicable RF compliance level above, the *ADview* device should be observed to verify normal operation. If abnormal performance is observed, additional measures may be necessary, such as re-orienting or relocating the *ADview* device.

^b Over the frequency range 150 kHz to 80 MHz, field strengths should be less than 3 V/m.

Recommended separation distances between portable and mobile RF communications equipment and the <i>ADview</i> device			
The <i>ADview</i> device is intended for use in an electromagnetic environment in which radiated RF disturbances are controlled. The customer or the user of the <i>ADview</i> device can help prevent electromagnetic interference by maintaining a minimum distance between portable and mobile RF communications equipment (transmitters) and the <i>ADview</i> device as recommended below, according to the maximum output power of the communications equipment.			
Rated maximum output power of transmitter W	Separation distance according to frequency of transmitter m		
	150 kHz to 80 MHz $d = [3.5/V_1] \sqrt{P}$	80 MHz to 800 MHz $d = [3.5/V_1] \sqrt{P}$	800MHz to 2.5GHz $d = [7/E_1] \sqrt{P}$
0.01	0.12	0.12	0.23
0.10	0.38	0.38	0.73
1	1.2	1.2	2.3
10	3.8	3.8	7.3
100	12	12	23
For transmitters rated at a maximum output power not listed above, the recommended separation distance <i>d</i> in meters (m) can be estimated using the equation applicable to the frequency of the transmitter, where <i>P</i> is the maximum output power rating of the transmitter in watts (W) according to the transmitter manufacturer. NOTE 1—At 80 MHz and 800 MHz, the separation distance for the higher frequency range applies. NOTE 2—These guidelines may not apply in all situations. Electromagnetic propagation is affected by absorption and reflection from structures, objects, and people.			

For units that are Bluetooth enabled, the following EU and FCC regulatory information applies:

EU Regulatory Information

The transmitter module manufactured by Mitsumi and incorporated into the AdView BP module marked by  has been approved in accordance with the R&TTE directive.

FCC Regulatory Information

FCC RF Interference Statement:

This equipment has been tested and found to comply with the limits pursuant to Part 15 of the FCC rules.

These limits are designed to provide reasonable protection against harmful interference in a residential installation.

This equipment generates, uses and radiates radio frequency energy and, if not installed and used in accordance with the instructions, may cause harmful interference to radio communication. However, there is no guarantee that interference will not occur in a particular installation. If this equipment does cause harmful interference to radio or television reception, which can be determined by turning the equipment off and on, the user is encouraged to try to correct the interference by one or more of the following measures:

- Reorient or relocate the receiving antenna.
- Increase the separation between the equipment and receiver.
- Connect the equipment into an outlet on a circuit different from that to which the receiver is connected.
- Consult the dealer or an experienced radio/TV technician for help.

Operation is subject to the following two conditions: (1) this device may not cause harmful interference, and (2) this device must accept any interference received, including interference that may cause undesired operation. This device contains FCC-ID P00WML-C40.

FCC RF Exposure Statement:

This device complies with FCC radiation exposure limits set forth for an uncontrolled environment. End users must follow the specific operation instructions for satisfying RF exposure compliance. This transmitter must not be co-located or operating in conjunction with any other antenna or transmitter.

This mobile modular transmitter must have a separation distance of at least 20 cm between the antenna and the body of the user or nearby persons. With a separation distance of 20 cm or more, the MPE limits are well above the potential this module is capable of producing.

Note: Unauthorized modifications will void the authority to use this equipment.

Limited Warranty

ADview Device

ADC by SunTech provides the original purchaser the following limited warranty from date of invoice.

All serialized modules	24 months
APC Cuff(s)	24 months
Roll stand	24 months
Accessories, i.e. patient cables, disposables, power supplies	90 days

ADC by SunTech warrants each instrument to be free from defects in material and workmanship. Liability under this warranty covers servicing of the instrument when returned from the customer's facility within the United States prepaid to the factory. *ADC* will repair any component(s) or part(s) that it finds to be defective during the period of this limited warranty. Should a defect become apparent, the original purchaser should first notify *ADC* of the suspected defect. The instrument should be carefully packaged and shipped prepaid to:

For customers in the Americas:

ADC by SunTech
Service Department
55 Commerce Drive
Hauppauge, NY 11788
USA
Tel: 631.273.9600
Fax: 631.273.9659

OR

For customers in Europe, Middle East, Africa, Asia, and the Pacific:

SunTech Medical, Ltd.
Service Department
Oakfield Industrial Estate
Eynsham, Oxfordshire OX29 4TS
UK
Tel: +44. 1865.884.234
Fax: +44. 1865.884.235

The instrument will be repaired in the shortest possible time and returned prepaid by the same shipping method as received by the factory. This limited warranty is void if the instrument has been damaged by accident, misuse, negligence, act of God or serviced by any person not authorized by *ADC*.

This limited warranty contains the entire obligation of *ADC* and no other warranties expressed, implied or statutory are given. No representative or employee of *ADC* is authorized to assume any further liability or grant any further warranties except as herein.

Purchasing Parts and Accessories

We recommend that you purchase parts and accessories for your *ADview* from your authorized *ADview* distributor. A consolidated list of parts and accessories appears below.

<i>ADview</i> Systems		
Item #	Item Name	Item Description
9000BPSTO 9000M	<i>ADview</i> Battery Mobile System, BP, Temperature & SpO ₂	BP Device with SpO ₂ , Temp, Rechargeable Battery and mobile stand & basket
9000BP 9000M	<i>ADview</i> Battery Mobile System, BP	BP Device with Rechargeable Battery and mobile stand & basket
9000BPTO 9000M	<i>ADview</i> Battery Mobile System, BP & Temperature	BP Device with Temp, Rechargeable Battery and mobile stand & basket
9000BPS 9000M	<i>ADview</i> Battery Mobile System, BP & SpO ₂	BP Device with SpO ₂ , Rechargeable Battery, and mobile stand & basket
9000BPSTO 9000W	<i>ADview</i> Wall System, BP, Temperature & SpO ₂	BP Device with SpO ₂ , Temp, Rechargeable Battery, and wall mount kit & basket
9000BP 9000W	<i>ADview</i> Wall System, BP	BP Device with Rechargeable Battery and wall mount kit & basket
9000BPTO 9000W	<i>ADview</i> Wall System, BP & Temperature	BP Device with Temp, Rechargeable Battery, and wall mount kit & basket
9000BPS 9000W	<i>ADview</i> Wall System, BP & SpO ₂	BP Device with SpO ₂ , Rechargeable Battery, and wall mount kit & basket
9000BPSTO 9000D	<i>ADview</i> Battery Tabletop System, BP, Temperature & SpO ₂	BP Device with SpO ₂ , Temp, Rechargeable Battery, and tabletop stand

9000BP 9000D	<i>ADview</i> Battery Tabletop System, BP	BP Device with Rechargeable Battery and tabletop stand
9000BPTO 9000D	<i>ADView</i> Battery Tabletop System, BP & Temperature	BP Device with Temp, Rechargeable Battery, and tabletop stand
9000BPS 9000D	<i>ADview</i> Battery Tabletop System, BP & SpO2	BP Device with SpO2, Rechargeable Battery, and tabletop stand

<i>ADview</i> Accessories		
Item #	Item Name	Item Description
9000TO	<i>ADview</i> Temperature Module, Oral	Thermometry Module for <i>ADview</i> BP with blue probe
9000TR	<i>ADview</i> Temperature Module, Rectal	Thermometry Module for <i>ADview</i> BP with red probe
9000S	<i>ADview</i> SpO ₂ Module	SpO ₂ Module for <i>ADview</i> BP
9000BPCAP	Top/bottom cover for <i>ADview BP</i>	Covers the top or bottom of a <i>ADview</i> BP device

All Purpose - General Clinical Use Cuffs		
Item #	Item Name	Item Description
9000CK	All Purpose Cuff package, All sizes	Includes Child, Small Adult, Adult, Large Adult, and Thigh cuffs with threaded screw type connectors
9000ACK	All Purpose Cuff package, Adult	Includes Adult, Large Adult, and Thigh cuffs with threaded screw type connectors
9000PCK	All Purpose Cuff package,	Includes Child, Small Adult, and

	Pediatric	Adult cuffs with threaded screw type connectors
850-9000-9CGR	All Purpose Cuff, Child	Blood Pressure Cuff with threaded screw type connector, Range: 12-19 cm, Color: Green
850-9000-10SARB	All Purpose Cuff, Small Adult	Blood Pressure Cuff with threaded screw type connector, Range: 17-25 cm, Color: Royal Blue
850-9000-11AN	All Purpose Cuff, Adult	Blood Pressure Cuff with threaded screw type connector, Range: 23-33 cm, Color: Navy Blue
850-9000-12XBD	All Purpose Cuff, Large Adult	Blood Pressure Cuff with threaded screw type connector, Range: 31-40 cm, Color: Burgundy
850-9000-13TBR	All Purpose Cuff, Thigh	Blood Pressure Cuff with threaded screw type connector, Range: 38-50 cm, Color: Brown
850-9000-9LCGR	All Purpose Cuff, Long Child	Blood Pressure Cuff with threaded screw type connector, Range: 12-19 cm, Color: Green
850-9000-10LSARB	All Purpose Cuff, Long Small Adult	Blood Pressure Cuff with threaded screw type connector, Range: 17-25 cm, Color: Royal Blue
850-9000-11LAN	All Purpose Cuff, Long Large Adult	Blood Pressure Cuff with threaded screw type connector, Range: 23-33 cm, Color: Navy

850-9000-12LXBD	All Purpose Cuff, Long Large Adult	Blood Pressure Cuff with threaded screw type connector, Range: 31-40 cm, Color: Burgundy
-----------------	------------------------------------	--

Pulse Oximetry Accessories		
Item #	Item Name	Item Description
9000SP10	Adult digit reusable oximetry sensor	Reusable finger sensor with 10' (3.048 m) cable and DB-9M connector for adults and pediatrics >88 lbs (>40 kg); Nellcor® compatible sensor DS-100A
9000SPDYS	Pediatric/Multi-Site Sensor (for ages 3yrs+)	Reusable universal Y multi site sensor with 36" (.91 m) cable and DB-9M connector for all patients >2.2lbs (>1 kg); Nellcor® compatible sensor D-YS and D-YSE

Thermometry Accessories		
Item #	Item Name	Item Description
9000TR-01	Red Rectal Temperature Kit	Includes rectal probe, well, and box of probe covers
9000TOP	Blue Oral/Axillary Probe	Oral/axillary probe with 9 ft (2.7 m) extended cord
9000TWB	Blue Oral/Axillary Well	Rear piece of the temperature module that holds the oral/axillary probe and box of probe covers

9000TRP	Red Rectal Probe	Rectal probe with 9 ft (2.7 m) extended cord
9000TWR	Red Rectal Well	Rear piece of the temperature module that holds the rectal probe and box of probe covers
9000TP	Disposable Probe Covers	25 boxes (500 probe covers)/case

Miscellaneous Accessories		
Item #	Item Name	Item Description
9000M	Mobile stand kit	Includes base, pole, power supply holder, storage basket, handle, and assembly instructions
9000D	Tabletop stand kit	Includes power supply holder
9000W	Wall mount kit	Includes wall mountable basket
952-025	Basket	Wall mountable
9000AC9V	Power supply for the <i>ADview</i> Battery	Input: 100-240 V, 50-60 Hz; Output: +9 V; medical grade
9000PCEU	EU power cord	Power or mains lead with Type E and F hybrid, CEE 7/7, two pin plug, 8.2 ft (2.5 m) length
9000PCUK	UK power cord	Power or mains lead with Type G, BS1363, three pin plug, 8.2 ft (2.5 m) length
9000PC	US power cord	Power or mains lead with Type B, NEMA 5-15. three pin plug, 8.2 ft (2.5m) length
9000BPC	BP hose	BP hose with mate for threaded screw type connector, 8 ft (2.4 m) length

9000BAT	Rechargeable battery	6V, sealed lead acid battery
93-9000UM-00	Service Manual	



ADC powered by SunTech

www.adctoday.com/adview

ADC by SunTech
 55 Commerce Drive
 Hauppauge, NY 11788
 USA
 Tel: 631.273.9600
 1.800.232.2670
 Fax: 631.273.9659

SunTech Medical, Ltd.
 Level 19, Two, International Finance Centre
 8, Finance Street, Central
 Hong Kong
 Tel: +852.2251.1949
 Fax: +852.2251.1950

SunTech Medical, Ltd.
 Service Department
 Oakfield Industrial Estate
 Eynsham, Oxfordshire OX29 4TS
 UK
 Tel: +44. 1865.884.234
 Fax: +44. 1865.884.235

IB p/n: 93-9000UM-00 rev 4

POLE STAND ASSEMBLY INSTRUCTIONS

Box Contents

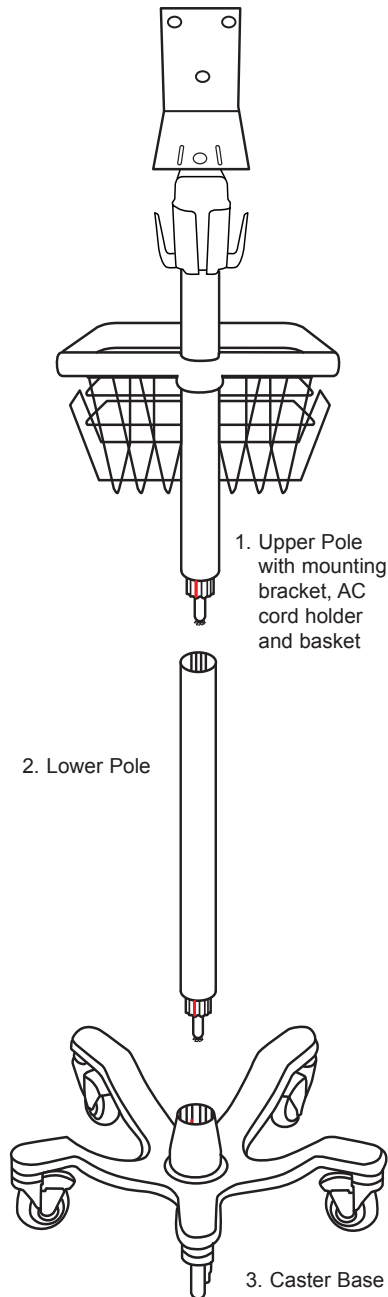

Assembly

***No Tools Required**

1. Align keyway (red) of Lower Pole with keyway (red) of Caster Base, and insert downward until fully seated.

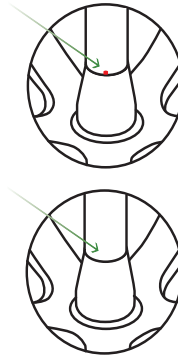
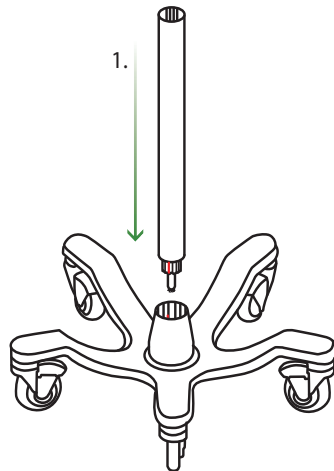

2. Align keyway (red) of Upper Pole and basket with keyway of Lower Pole (red), and insert downward until fully seated.

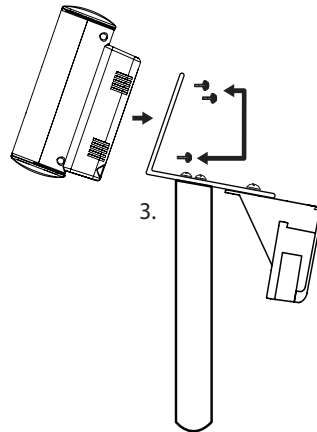
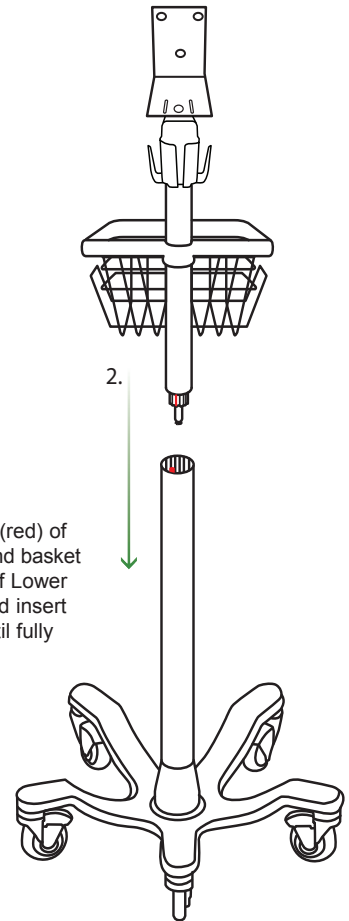

3. Align holes on rear of BP module with the 3 holes on the mounting plate as shown. Hand-tighten 3 mounting screws through rear of mounting plate into BP module.



ADC
55 Commerce Drive
Hauppauge, NY 11788

Inspected in the U.S.A.
Made in China
tel: 631-273-9600
toll free: 1-800-232-2670
fax: 631-273-9659



Suntech Medical Ltd.
Oakfield Industrial Estate
Eynsham, Oxfordshire
OX29 4TS UK

www.adctoday.com/adview
info@adctoday.com

To Register Your Product, visit us at
www.adctoday.com
and follow the links

For questions, comments, or suggestions,
call in the U.S.A. Toll Free:
1-800-ADC-2670

The following instructions guide you in adding the pulse oximetry module to the **ADC AdView™ Modular Diagnostic Station**. Included in the Pulse Oximetry Module kit are the pulse oximetry module and the adult reusable sensor. The pulse oximetry module attaches to the bottom of the BP module.

Adding the Pulse Oximeter Module

1. Using the power button on the right side of the BP module, ensure that the **ADC AdView™ Modular Diagnostic Station** is off.
2. Remove the cover plate from the bottom of the main BP module.
3. Slide the pulse oximetry module along the guides on the bottom of the main BP module from front to back until it snaps into place. All the segments of the pulse oximetry module display will light when the modules have been connected correctly.



4. Turn the device on using the power button on the right side of the BP module. At the end of the start-up sequence, the pulse oximetry module display will be blank except for the "%SpO₂" symbol.
5. Turn the device off, then connect the SpO₂ cable to the connector on the module. Secure the cable to your device using the retention clip.

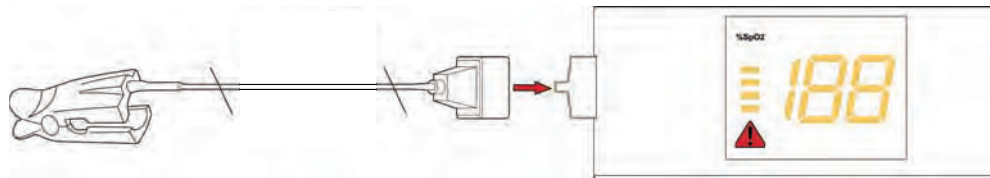

6. Turn the device on. All display segments light up for three to five seconds. A short beep indicates that the **ADC AdView™ Modular Diagnostic Station** is ready.

Note: If the pulse oximetry module does not appear to be working properly, cycle the power several times using the power button on the right side of the BP module. This will “synchronize” all the modules. The modules are synchronized when, after you turn the power on, all segments on all modules display light simultaneously for 3 to 5 seconds, followed by a short beep, and all displays go to their “ready” state (BP: battery icon and middle segments of the systolic value are lit; Temperature: appropriate temperature units icon is lit; Pulse Oximetry: the “%SpO2” icon is lit).

Refer to the *ADC AdView™ Modular Diagnostic Station* user’s manual for operation, maintenance and safety instructions.



ADC
55 Commerce Drive
Hauppauge, NY 11788



Suntech Medical, Ltd.
Oakfield Industrial Estate
Eynsham, Oxfordshire
OX29 4TS UK

Inspected in the U.S.A.
Made in China
tel: 631-273-9600
toll free: 1-800-232-2670
fax: 631-273-9659

www.adctoday.com/adview
info@adctoday.com

Printed in the USA

To Register Your Product, visit us at
www.adctoday.com
and follow the links

For questions, comments, or suggestions,
call in the U.S.A. Toll Free:
1-800-ADC-2670

REFERENCE CARD

Proper Blood Pressure Cuff Sizing

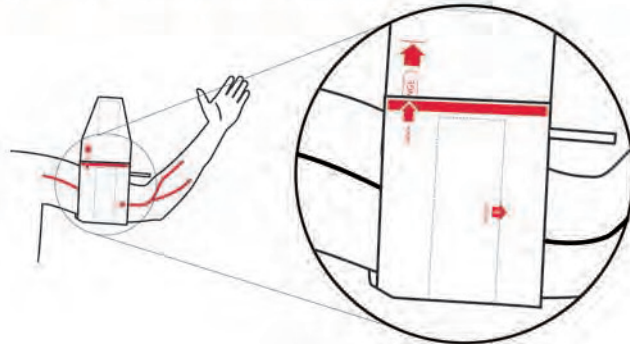

Index line at cuff edge should fall within the Range arrows.

IF white Index line does not reach first Range arrow, select a larger cuff.

Using a cuff that is too small (undercuffing) can result in overestimating a patient's BP.

IF white Index line reaches past second Range arrow, select a smaller cuff.

Using a cuff that is too large (overcuffing) can result in overestimating a patient's BP.

BE SURE TO USE APPROPRIATE SIZE CUFF FOR YOUR PATIENT.

(See chart below for cuff size options. Be sure to select appropriate connector.)

Cuff Size - Color/Limb Circumference					Quick Connect Adapter 891PF-00
Child	Small Adult	Adult	Large Adult	Thigh	
12-19cm	17-25cm	23-33cm	31-40cm	38-50cm	



ADC
55 Commerce Drive
Hauppauge, NY 11788

Suntech Medical, Ltd.
Oakfield Industrial Estate
Eynsham, Oxfordshire
OX29 4TS UK

Inspected in the U.S.A.
Made in China
tel: 631-273-9600
toll free: 1-800-232-2670
fax: 631-273-9659

www.adctoday.com/adview
info@adctoday.com

IB p/n 93-900RR-00
Printed in the USA



Measuring Blood Pressure Automatically

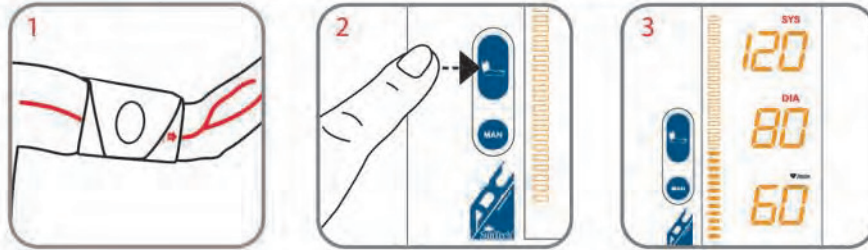

Measuring Blood Pressure with Manual SphygMode™

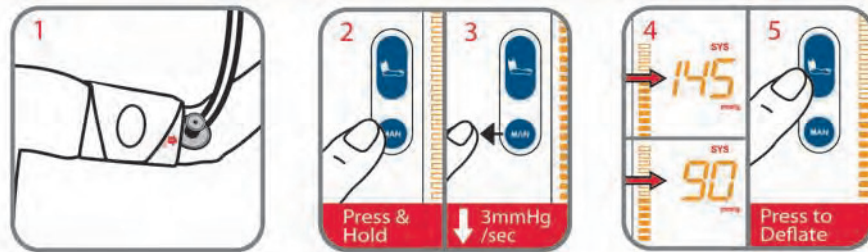

Recall Data

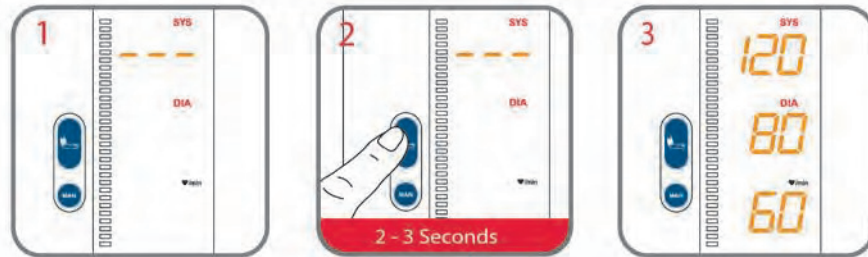

Clear Data

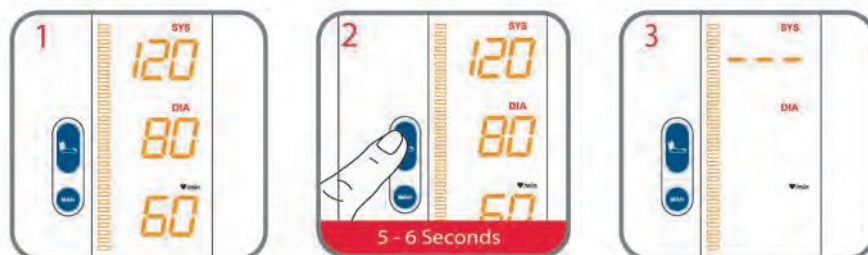

Bird's Eye View Key:
Hardware - Interface

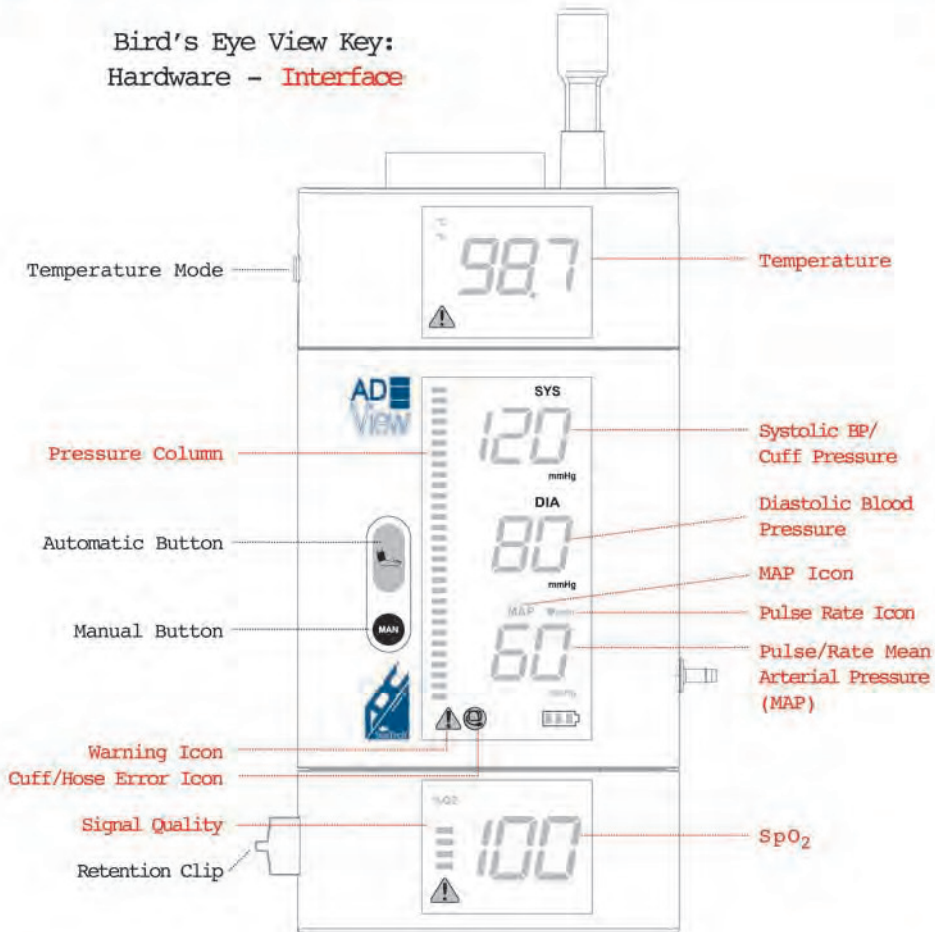

Versions



Blood Pressure (BP)

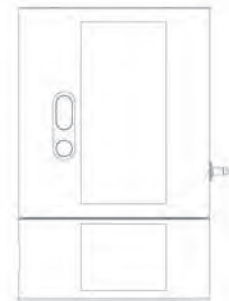

BP and SpO₂

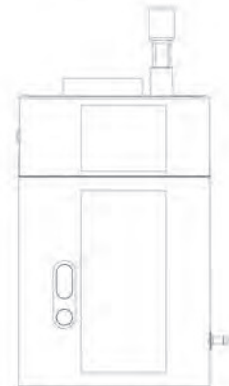

BP and Temperature



BP, SpO₂, and Temp

Contents & Accessories



Users Manual CD

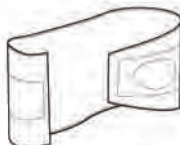

BP Cuff (2)

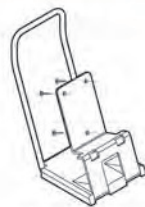

Tabletop Mount



Temperature Probe



Probe Covers

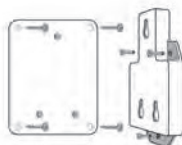

Wall Bracket



SpO₂ Extension Cable



SpO₂ Sensor



Mobile Stand
(Shipped Separately)

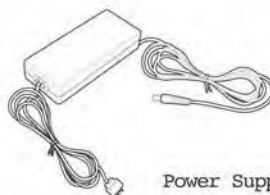

Power Supply



BP Cable

Mounting

The Adviev™ can be mounted in the following ways:

1. Tabletop

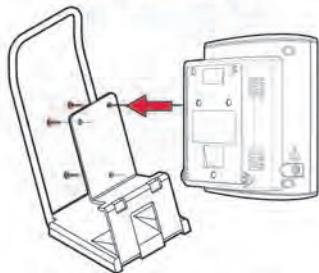

Using the thumbscrews, secure the rear panel of the BP device to the stand.

2. Wall

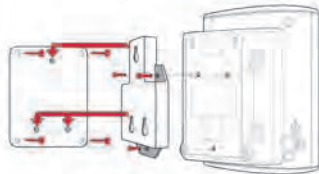

- Attach the bracket to the wall using 4 wall screws, and the basket using 2 screws.
- Attach the wall bracket adapter to the rear panel of the BP device using the 3 screws.
- Position the adapter onto the rivets of the wall bracket and slide the device down until it locks into place.

3. Mobile Stand

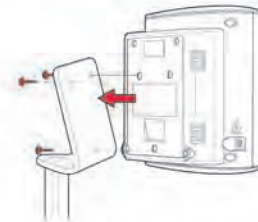

Assemble the mobile stand according to the manufacturer's directions. Using the three thumbscrews, secure the rear panel of the BP device to the stand.

First Time Setup & Operation

1. Assembling the Temperature Module for Use



Place the probe cover box into holder.

2. Connecting the SpO₂ Sensor

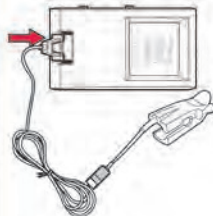

- Connect the sensor to the extension cable.
- Flip the retention clip forward, then connect the cable to the device.
- Finally, push the clip backward over the SpO₂ connector to hold the connector in the device.

3. Connecting Power



- Connect the power supply to the BP module.
- Connect the power supply to an AC main power source. The device will turn on automatically.

Before using the device, fully charge the battery for eight hours.

4. Changing the Unit of Temp Measurement



Using the end of a paper clip or similar tool, press the recessed button on the temp module. The icon for the selected unit is displayed.

5. Adjusting Mobile Stand Height

Use the one hand height adjustment on the mobile stand to adjust the height of the device on the pole. Grip the pole immediately below the black stopper.

With your thumb and forefinger, push the stopper upwards and raise or lower the pole height.



6. Attaching the Quick Reference Card to Basket

Use the four plastic ties to attach the numbered cards to the front side of the basket.



ADC
55 Commerce Drive
Hauppauge, NY 11788



Suntech Medical, Ltd.
Oakfield Industrial Estate
Eynsham, Oxfordshire
OX29 4TS UK

www.adctoday.com/adviev
info@adctoday.com

Inspected in the U.S.A.
Made in China
tel: 631-273-9600
toll free: 1-800-232-2670
fax: 631-273-9659

To Register Your Product, visit us at
www.adctoday.com
and follow the links

For questions, comments, or suggestions,
call in the U.S.A. Toll Free:
1-800-ADC-2670

1a. Attaching the Temp Probe Connector

With the black side facing down, slide the black connector at the end of the probe cord into the notches on the probe holder as shown.

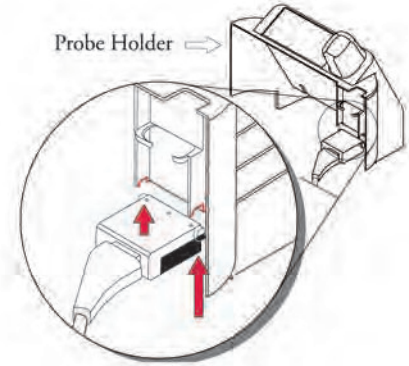

1b. Attaching the Temp Probe Connector

Rotate the connector up until it snaps into the retention notches (shown in red). The connector should fit snugly.

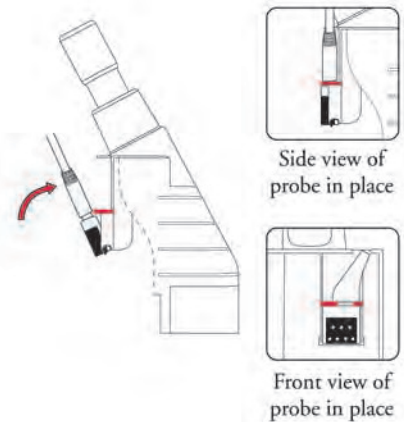

2. Assembling the Temp Module for Use

- a. Slide the probe cover box holder onto the temperature module.
- b. Place probe in well.
- c. Place the probe cover box into the holder.

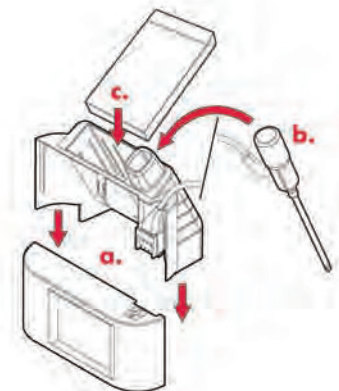

ADC
55 Commerce Drive
Hauppauge, NY 11788

Suntech Medical, Ltd.
Oakfield Industrial Estate
Eynsham, Oxfordshire
OX29 4TS UK

Inspected in the U.S.A.
Made in China
tel: 631-273-9600
toll free: 1-800-232-2670
fax: 631-273-9659

www.adctoday.com/adview
info@adctoday.com

To Register Your Product, visit us at
www.adctoday.com
and follow the links

For questions, comments, or suggestions,
call in the U.S.A. Toll Free:
1-800-ADC-2670

1a. Attaching the Temp Probe Connector

With the black side facing down, slide the black connector at the end of the probe cord into the notches on the probe holder as shown.

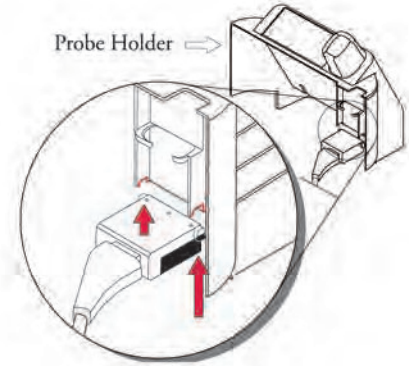

1b. Attaching the Temp Probe Connector

Rotate the connector up until it snaps into the retention notches (shown in red). The connector should fit snugly.

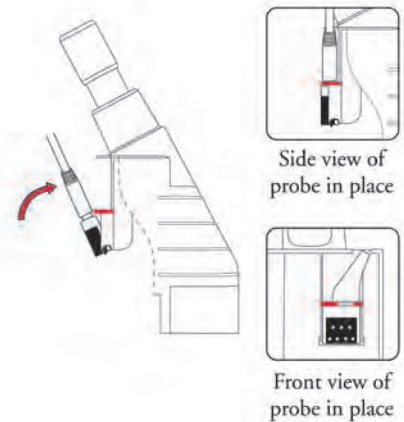

2. Assembling the Temp Module for Use

- a. Slide the probe cover box holder onto the temperature module.
- b. Place probe in well.
- c. Place the probe cover box into the holder.

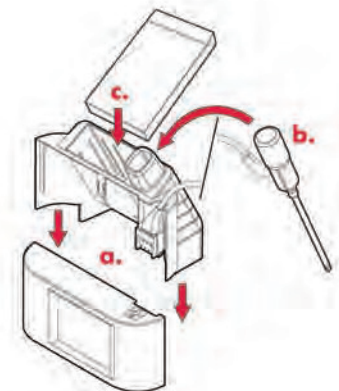

ADC
55 Commerce Drive
Hauppauge, NY 11788

Suntech Medical, Ltd.
Oakfield Industrial Estate
Eynsham, Oxfordshire
OX29 4TS UK

Inspected in the U.S.A.
Made in China
tel: 631-273-9600
toll free: 1-800-232-2670
fax: 631-273-9659

www.adctoday.com/adview
info@adctoday.com

To Register Your Product, visit us at
www.adctoday.com
and follow the links

For questions, comments, or suggestions,
call in the U.S.A. Toll Free:
1-800-ADC-2670

The following instructions guide you in adding the temperature module to the **ADC AdView™ Modular Diagnostic Station**. Included in the Temperature Module Kit are the temperature module, oral temperature probe, and a box of probe covers. The temperature module attaches to the top of the BP module.

It is made up of the following two pieces:

- Part A with the display.
- Part B, the probe holder, which holds the temperature probe and probe cover box.

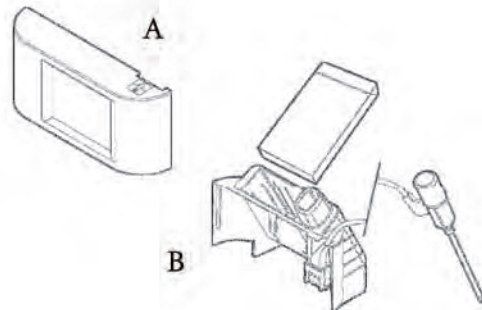

Adding the Temperature Module

1. Using the power button on the right side of the BP module, ensure that the **ADC AdView™ Modular Diagnostic Station** is turned off.
2. Remove the cover plate from the top of the BP module.
3. Slide part A of the temperature module along the guides on the top of the BP module from front to back until it snaps into place. All the segments of the temperature module display will light when the modules have been connected correctly.

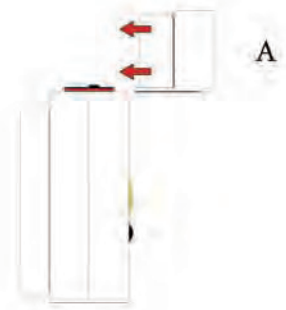
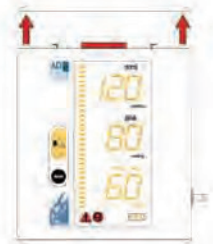

- Attach the temperature probe connector to part B as follows: with the black surface facing downward, hold the probe connector end against the notches on the probe holder, as shown in red (step 1 shown below).

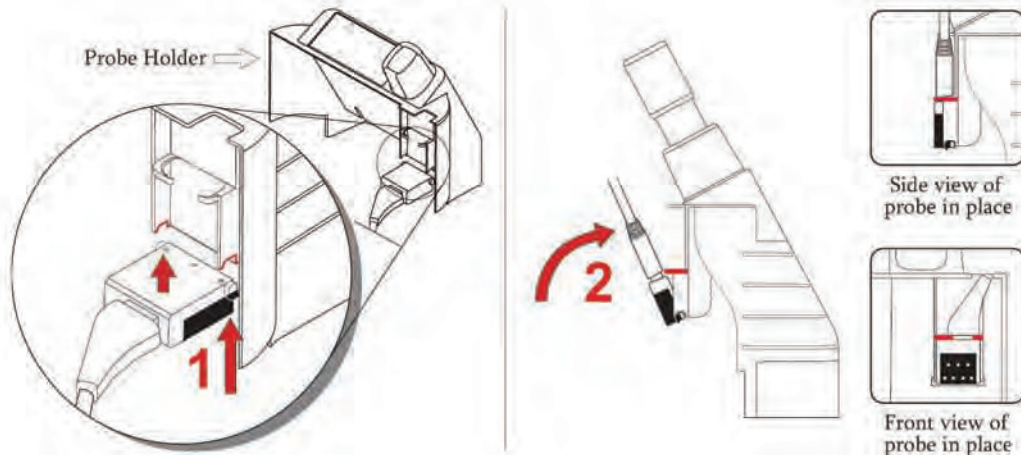

- Rotate the connector upwards until it snaps securely into place (step 2 shown above). The black surface faces outward and the cord extends upward.
- Slide part B onto part A as shown (this connects the temperature probe connector to the temperature unit connector), and insert the temperature probe into the well.
- Turn the device on using the power button on the right side of the BP module. At the end of the start-up sequence, the temperature module display will be blank except for the appropriate temperature unit icon (°F or °C). A short beep indicates that the **ADC AdView™ Modular Diagnostic Station** is ready.

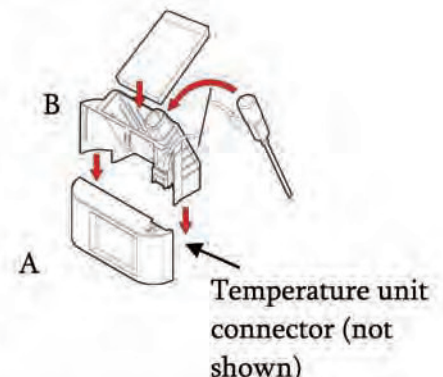

Note: If the temperature module does not appear to be working properly, cycle the power several times using the power button on the right side of the BP module. This will “synchronize” all the modules. The modules are synchronized when, after you turn the power on, all segments on all modules display light simultaneously for 3 to 5 seconds, followed by a short beep, and all displays go to their “ready” state (*BP: battery icon and middle segments of the systolic value are lit; Temperature: appropriate temperature units icon is lit; Pulse Oximetry: the “%SpO2” icon is lit*).

Refer to the **ADC AdView™ Modular Diagnostic Station** user’s manual for operation, maintenance and safety instructions.



ADC
55 Commerce Drive
Hauppauge, NY 11788



Suntech Medical, Ltd.
Oakfield Industrial Estate
Eynsham, Oxfordshire
OX29 4TS UK

Inspected in the U.S.A.
Made in China
tel: 631-273-9600
toll free: 1-800-232-2670
fax: 631-273-9659

www.adctoday.com/adview
info@adctoday.com

Printed in the USA

To Register Your Product, visit us at
www.adctoday.com
and follow the links

For questions, comments, or suggestions,
call in the U.S.A. Toll Free:
1-800-ADC-2670

1. Pieces & Parts



1x Wall Bracket

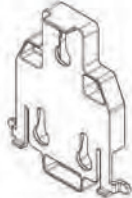

1x Wall Bracket Adaptor



1x Wall Basket

2. Attaching the Wall Bracket

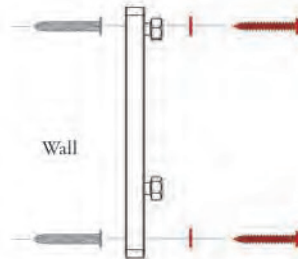
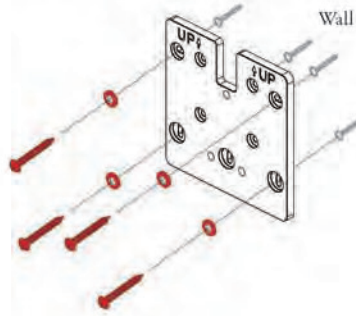

3. Attaching the Wall Bracket Adaptor

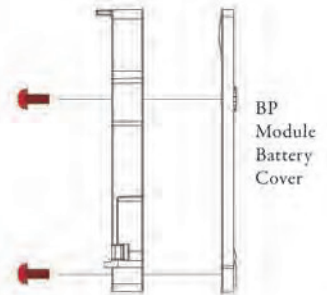
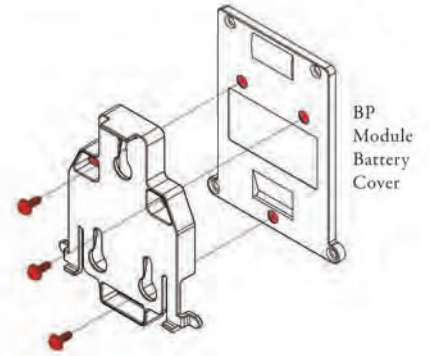

4a. Attaching the BP Module

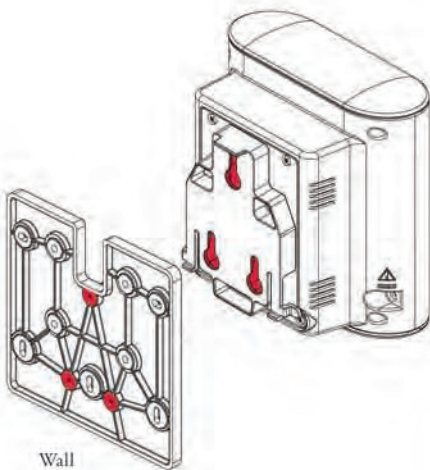

4b. Attaching the BP Module

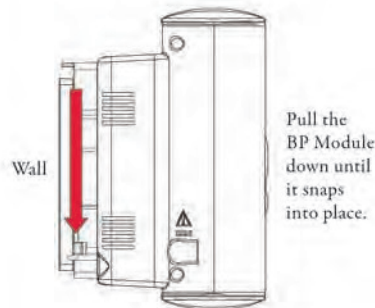
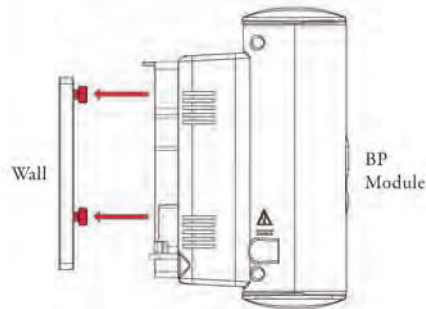

5. Attaching the Wall Basket

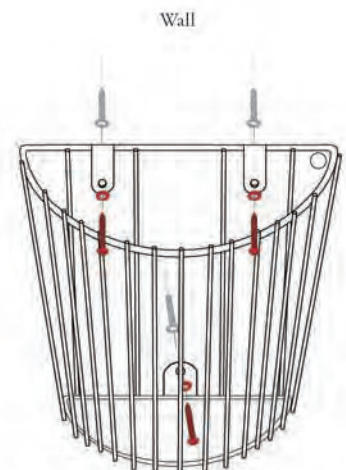

1. Replacing a Welch Allyn Wall Aneroid

- a. Remove the screw at the bottom of the basket behind the wall aneroid.
- b. Remove the aneroid.
- c. Remove the top two screws connecting the basket to the wall.
- d. Slide the basket up and towards you to remove it from the wall.

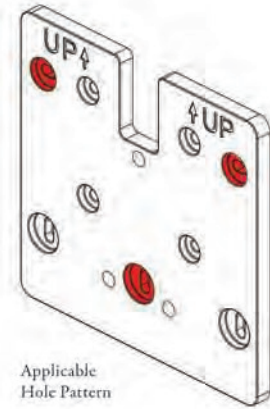

2. Replacing an ADC Wall Aneroid

- a. Remove the screws at the top and the bottom of the wall aneroid.
- b. Remove the aneroid.
- c. Remove the screws attaching the bracket to the wall.

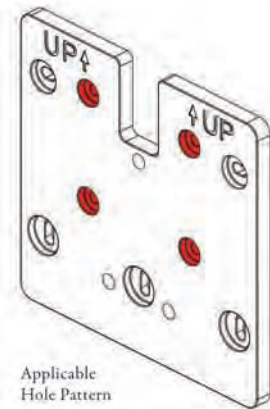

3. Replacing a Medline Wall Aneroid

- a. Remove the screws at the top and the bottom of the wall aneroid.
- b. Remove the aneroid.
- c. Remove the screws attaching the bracket to the wall.

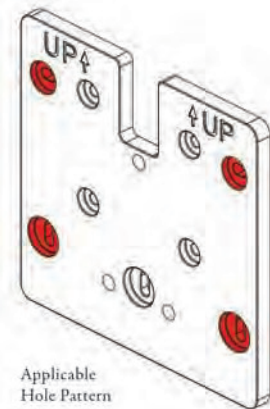

ADC
55 Commerce Drive
Hauppauge, NY 11788



Suntech Medical, Ltd.
Oakfield Industrial Estate
Eynsham, Oxfordshire
OX29 4TS UK

Inspected in the U.S.A.
Made in China
tel: 631-273-9600
toll free: 1-800-232-2670
fax: 631-273-9659

www.adctoday.com/adview
info@adctoday.com

To Register Your Product, visit us at
www.adctoday.com
and follow the links

For questions, comments, or suggestions,
call in the U.S.A. Toll Free:
1-800-ADC-2670